

# Berkeley Math Circle

## Partitions

Peter Koroteev  
UC Berkeley

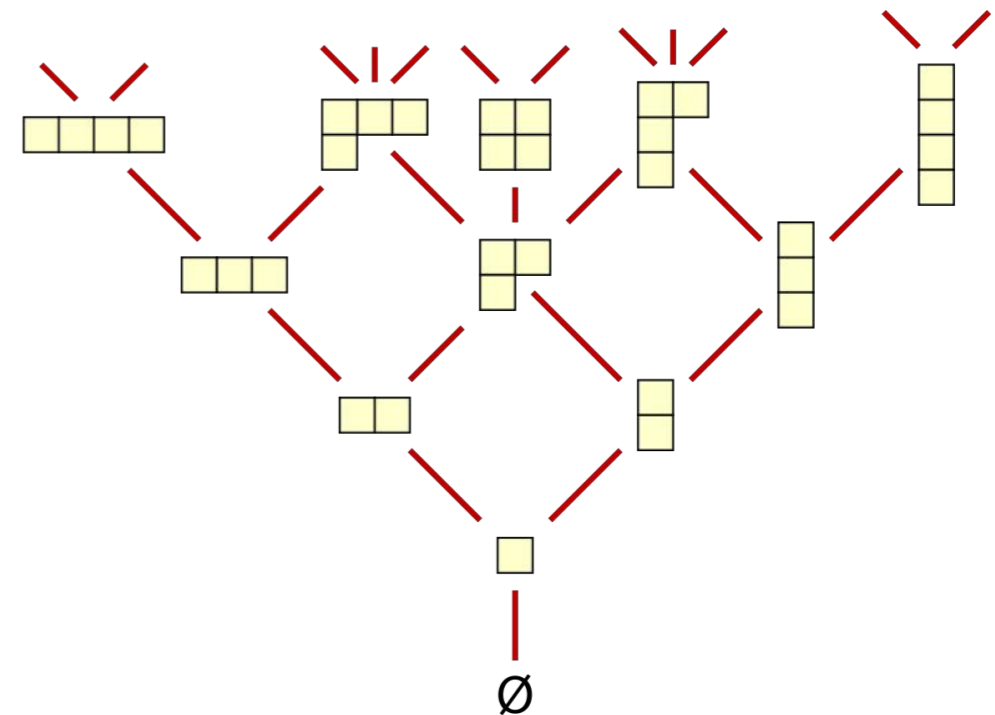
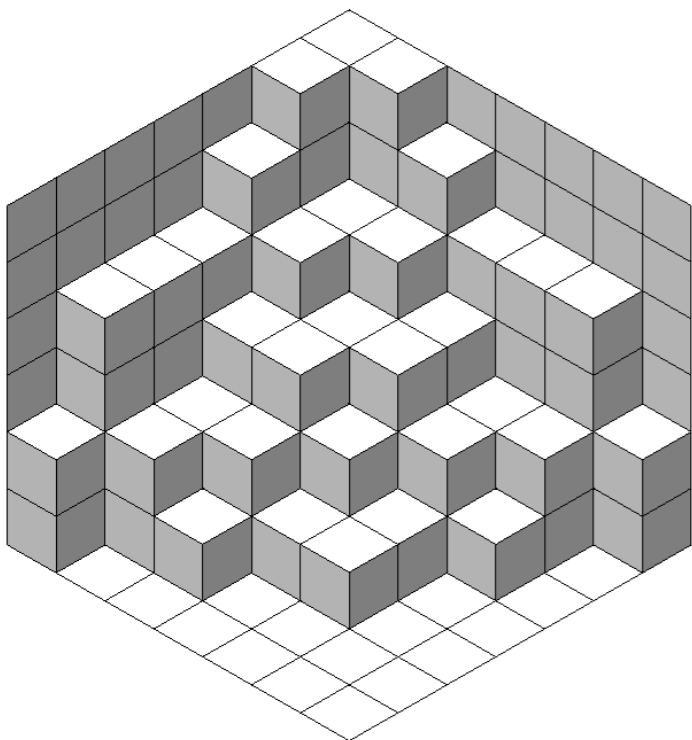

# Partitions

There are several ways to decompose an integer into sums of smaller integers

$$4=1+1+1+1$$



$$4=2+1+1$$

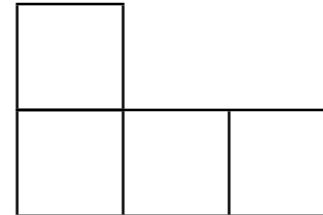

$$4=2+2$$

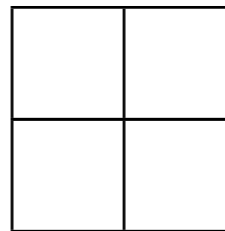

Young diagrams

$$4=3+1$$

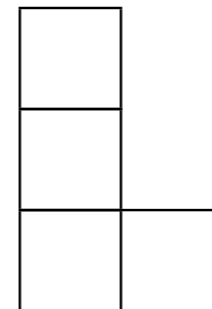

$$4=4+0$$



# Partitions

**Problem:** Find all partitions of numbers 1,2,3,4,5,6,7,8,9 together with their Young diagrams

**n=5**

**p(5)=7**

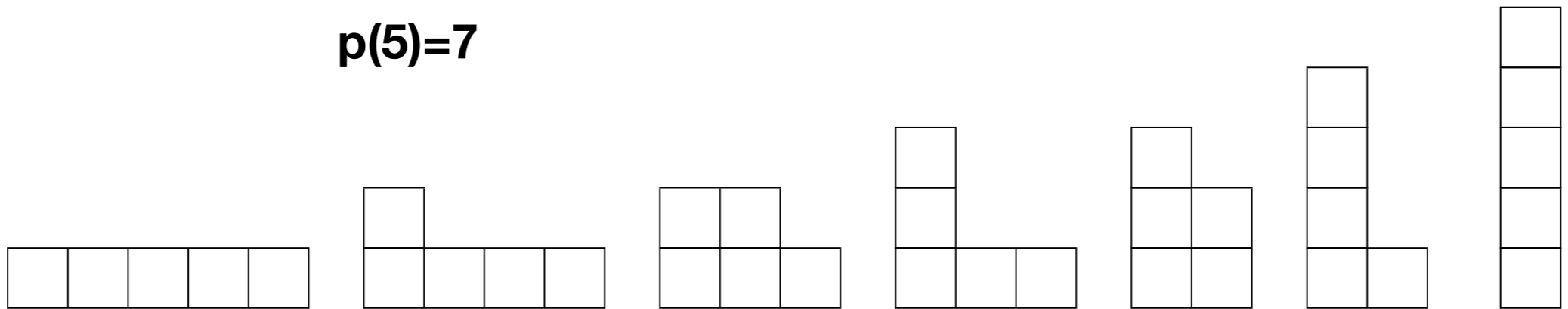

**n=6**

**p(6)=11**

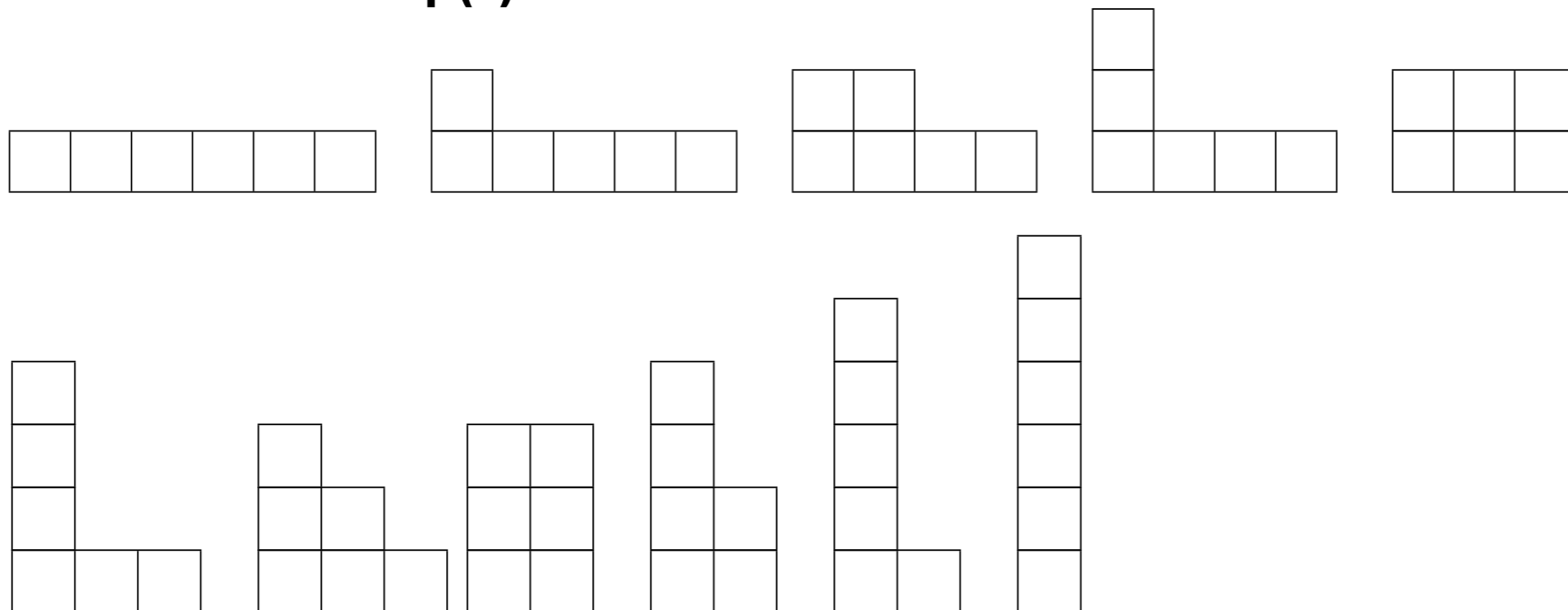

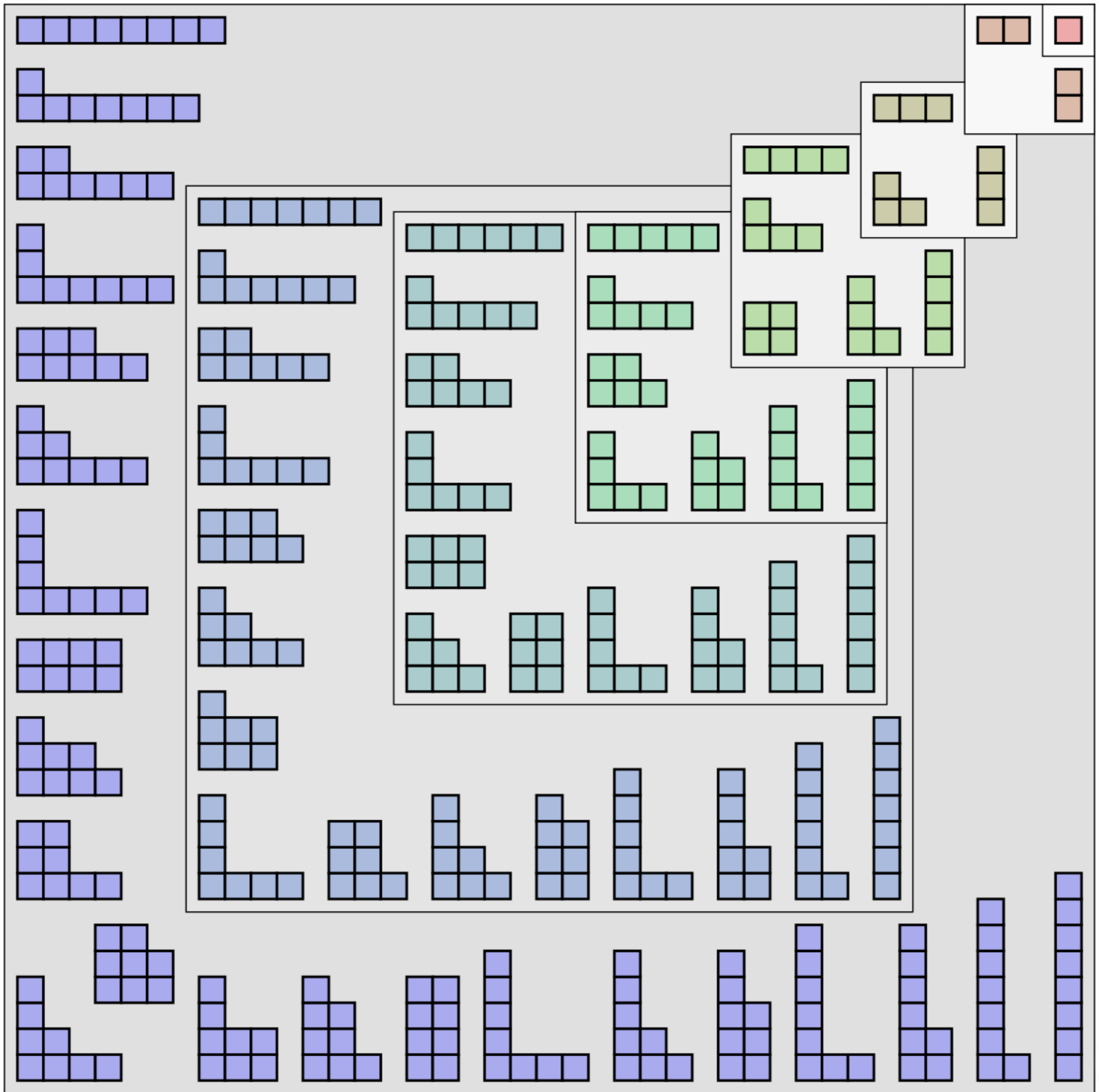

# Partitions

**n=7**

**p(7)=15**

{7}, {6, 1}, {5, 2}, {5, 1, 1}, {4, 3}, {4, 2, 1}, {4, 1, 1, 1}, {3, 3, 1}, {3, 2, 2}, {3, 2, 1, 1},  
{3, 1, 1, 1, 1}, {2, 2, 2, 1}, {2, 2, 1, 1, 1}, {2, 1, 1, 1, 1, 1}, {1, 1, 1, 1, 1, 1, 1}

**n=8**

**p(8)=22**

{8}, {7, 1}, {6, 2}, {6, 1, 1}, {5, 3}, {5, 2, 1}, {5, 1, 1, 1}, {4, 4}, {4, 3, 1}, {4, 2, 2}, {4, 2, 1, 1},  
{4, 1, 1, 1, 1}, {3, 3, 2}, {3, 3, 1, 1}, {3, 2, 2, 1}, {3, 2, 1, 1, 1}, {3, 1, 1, 1, 1, 1}, {2, 2, 2, 2},  
{2, 2, 2, 1, 1}, {2, 2, 1, 1, 1, 1}, {2, 1, 1, 1, 1, 1, 1}, {1, 1, 1, 1, 1, 1, 1, 1}

**n=9**

**p(9)=30**

{9}, {8, 1}, {7, 2}, {7, 1, 1}, {6, 3}, {6, 2, 1}, {6, 1, 1, 1}, {5, 4}, {5, 3, 1}, {5, 2, 2}, {5, 2, 1, 1},  
{5, 1, 1, 1, 1}, {4, 4, 1}, {4, 3, 2}, {4, 3, 1, 1}, {4, 2, 2, 1}, {4, 2, 1, 1, 1}, {4, 1, 1, 1, 1, 1},  
{3, 3, 3}, {3, 3, 2, 1}, {3, 3, 1, 1, 1}, {3, 2, 2, 2}, {3, 2, 2, 1, 1}, {3, 2, 1, 1, 1, 1},  
{3, 1, 1, 1, 1, 1, 1}, {2, 2, 2, 2, 1}, {2, 2, 2, 1, 1, 1}, {2, 2, 1, 1, 1, 1, 1}, {2, 1, 1, 1, 1, 1, 1, 1},  
{1, 1, 1, 1, 1, 1, 1, 1, 1}

# Odd & Distinct Parts

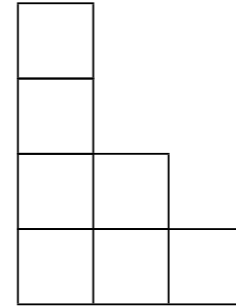
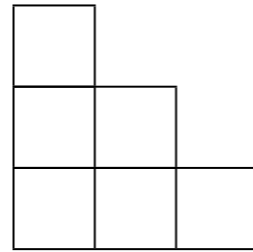
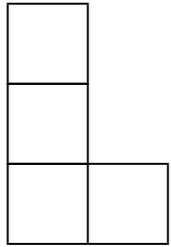

**Problem (a):** Count the number of partitions with *odd parts* from the previous examples

**Problem (b):** Count the number of partitions with *distinct parts* from the previous examples

**n=7**

**p(7)=15**

{7}, {6, 1}, {5, 2}, {5, 1, 1}, {4, 3}, {4, 2, 1}, {4, 1, 1, 1}, {3, 3, 1}, {3, 2, 2}, {3, 2, 1, 1},  
{3, 1, 1, 1, 1}, {2, 2, 2, 1}, {2, 2, 1, 1, 1}, {2, 1, 1, 1, 1, 1}, {1, 1, 1, 1, 1, 1, 1}

**n=8**

**p(8)=22**

{8}, {7, 1}, {6, 2}, {6, 1, 1}, {5, 3}, {5, 2, 1}, {5, 1, 1, 1}, {4, 4}, {4, 3, 1}, {4, 2, 2}, {4, 2, 1, 1},  
{4, 1, 1, 1, 1}, {3, 3, 2}, {3, 3, 1, 1}, {3, 2, 2, 1}, {3, 2, 1, 1, 1}, {3, 1, 1, 1, 1, 1}, {2, 2, 2, 2},  
{2, 2, 2, 1, 1}, {2, 2, 1, 1, 1, 1}, {2, 1, 1, 1, 1, 1, 1}, {1, 1, 1, 1, 1, 1, 1, 1}

**n=9**

**p(9)=30**

{9}, {8, 1}, {7, 2}, {7, 1, 1}, {6, 3}, {6, 2, 1}, {6, 1, 1, 1}, {5, 4}, {5, 3, 1}, {5, 2, 2}, {5, 2, 1, 1},  
{5, 1, 1, 1, 1}, {4, 4, 1}, {4, 3, 2}, {4, 3, 1, 1}, {4, 2, 2, 1}, {4, 2, 1, 1, 1}, {4, 1, 1, 1, 1, 1},  
{3, 3, 3}, {3, 3, 2, 1}, {3, 3, 1, 1, 1}, {3, 2, 2, 2}, {3, 2, 2, 1, 1}, {3, 2, 1, 1, 1, 1},  
{3, 1, 1, 1, 1, 1, 1}, {2, 2, 2, 2, 1}, {2, 2, 2, 1, 1, 1}, {2, 2, 1, 1, 1, 1, 1}, {2, 1, 1, 1, 1, 1, 1, 1},  
{1, 1, 1, 1, 1, 1, 1, 1, 1}

# Odd & Distinct Partitions

Find **odd and distinct** partitions for  $n = 1, 2, \dots, 11$

**$n=9$ ,  $p(9)=30$**

$\{9\}$ ,  $\{8, 1\}$ ,  $\{7, 2\}$ ,  $\{7, 1, 1\}$ ,  $\{6, 3\}$ ,  $\{6, 2, 1\}$ ,  $\{6, 1, 1, 1\}$ ,  $\{5, 4\}$ ,  $\{5, 3, 1\}$ ,  $\{5, 2, 2\}$ ,  $\{5, 2, 1, 1\}$ ,  
 $\{5, 1, 1, 1, 1\}$ ,  $\{4, 4, 1\}$ ,  $\{4, 3, 2\}$ ,  $\{4, 3, 1, 1\}$ ,  $\{4, 2, 2, 1\}$ ,  $\{4, 2, 1, 1, 1\}$ ,  $\{4, 1, 1, 1, 1, 1\}$ ,  $\{3, 3, 3\}$ ,  
 $\{3, 3, 2, 1\}$ ,  $\{3, 3, 1, 1, 1\}$ ,  $\{3, 2, 2, 2\}$ ,  $\{3, 2, 2, 1, 1\}$ ,  $\{3, 2, 1, 1, 1, 1\}$ ,  $\{3, 1, 1, 1, 1, 1, 1\}$ ,  $\{2, 2, 2, 2, 1\}$   
 $\{2, 2, 2, 1, 1, 1\}$ ,  $\{2, 2, 1, 1, 1, 1, 1\}$ ,  $\{2, 1, 1, 1, 1, 1, 1, 1\}$ ,  $\{1, 1, 1, 1, 1, 1, 1, 1, 1\}$

**$n=10$ ,  $p(10)=42$**

$\{10\}$ ,  $\{9, 1\}$ ,  $\{8, 2\}$ ,  $\{8, 1, 1\}$ ,  $\{7, 3\}$ ,  $\{7, 2, 1\}$ ,  $\{7, 1, 1, 1\}$ ,  $\{6, 4\}$ ,  $\{6, 3, 1\}$ ,  $\{6, 2, 2\}$ ,  $\{6, 2, 1, 1\}$ ,  
 $\{6, 1, 1, 1, 1\}$ ,  $\{5, 5\}$ ,  $\{5, 4, 1\}$ ,  $\{5, 3, 2\}$ ,  $\{5, 3, 1, 1\}$ ,  $\{5, 2, 2, 1\}$ ,  $\{5, 2, 1, 1, 1\}$ ,  $\{5, 1, 1, 1, 1, 1\}$ ,  
 $\{4, 4, 2\}$ ,  $\{4, 4, 1, 1\}$ ,  $\{4, 3, 3\}$ ,  $\{4, 3, 2, 1\}$ ,  $\{4, 3, 1, 1, 1\}$ ,  $\{4, 2, 2, 2\}$ ,  $\{4, 2, 2, 1, 1\}$ ,  $\{4, 2, 1, 1, 1, 1\}$ ,  
 $\{4, 1, 1, 1, 1, 1, 1\}$ ,  $\{3, 3, 3, 1\}$ ,  $\{3, 3, 2, 2\}$ ,  $\{3, 3, 2, 1, 1\}$ ,  $\{3, 3, 1, 1, 1, 1\}$ ,  $\{3, 2, 2, 2, 1\}$ ,  $\{3, 2, 2, 1, 1, 1\}$ ,  
 $\{3, 2, 1, 1, 1, 1, 1\}$ ,  $\{3, 1, 1, 1, 1, 1, 1, 1\}$ ,  $\{2, 2, 2, 2, 2\}$ ,  $\{2, 2, 2, 2, 1, 1\}$ ,  $\{2, 2, 2, 1, 1, 1, 1\}$ ,  
 $\{2, 2, 1, 1, 1, 1, 1, 1\}$ ,  $\{2, 1, 1, 1, 1, 1, 1, 1, 1\}$ ,  $\{1, 1, 1, 1, 1, 1, 1, 1, 1, 1\}$



**n=11, p(11)=56**

{ {11}, {10, 1}, {9, 2}, {9, 1, 1}, {8, 3}, {8, 2, 1}, {8, 1, 1, 1}, {7, 4}, {7, 3, 1}, {7, 2, 2}, {7, 2, 1, 1},  
{7, 1, 1, 1, 1}, {6, 5}, {6, 4, 1}, {6, 3, 2}, {6, 3, 1, 1}, {6, 2, 2, 1}, {6, 2, 1, 1, 1}, {6, 1, 1, 1, 1, 1}, {5, 5, 1},  
{5, 4, 2}, {5, 4, 1, 1}, {5, 3, 3}, {5, 3, 2, 1}, {5, 3, 1, 1, 1}, {5, 2, 2, 2}, {5, 2, 2, 1, 1}, {5, 2, 1, 1, 1, 1},  
{5, 1, 1, 1, 1, 1, 1}, {4, 4, 3}, {4, 4, 2, 1}, {4, 4, 1, 1, 1}, {4, 3, 3, 1}, {4, 3, 2, 2}, {4, 3, 2, 1, 1}, {4, 3, 1, 1, 1, 1},  
{4, 2, 2, 2, 1}, {4, 2, 2, 1, 1, 1}, {4, 2, 1, 1, 1, 1, 1}, {4, 1, 1, 1, 1, 1, 1, 1}, {3, 3, 3, 2}, {3, 3, 3, 1, 1}, {3, 3, 2, 2, 1},  
{3, 3, 2, 1, 1, 1}, {3, 3, 1, 1, 1, 1, 1}, {3, 2, 2, 2, 2}, {3, 2, 2, 2, 1, 1}, {3, 2, 2, 1, 1, 1, 1}, {3, 2, 1, 1, 1, 1, 1, 1},  
{3, 1, 1, 1, 1, 1, 1, 1, 1}, {2, 2, 2, 2, 2, 1}, {2, 2, 2, 2, 1, 1, 1}, {2, 2, 2, 1, 1, 1, 1, 1}, {2, 2, 1, 1, 1, 1, 1, 1, 1},  
{2, 1, 1, 1, 1, 1, 1, 1, 1, 1}, {1, 1, 1, 1, 1, 1, 1, 1, 1, 1} }

# Odd vs. Distinct

n	1	2	3	4	5	6	7	8	9
p(n)	1	2	3	5	7	11	15	22	30
# odd	1	1	2	2	3	4	5	6	8
# dist.	1	1	2	2	3	4	5	6	8

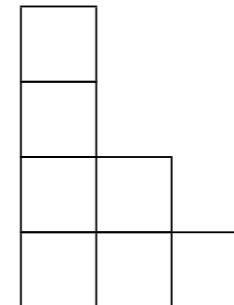
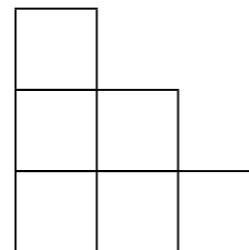
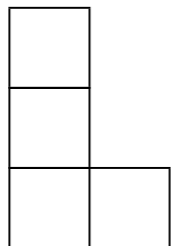

**Problem:** Why is the number of these partitions is the same for every n?

odd	distinct
5	5
3,1,1	4,1
1,1,1,1,1	3,2

odd	distinct
5,1	6
3,3	5,1
3,1,1,1	4,2
1,1,1,1,1,1	3,2,1

odd	distinct
7	7
5,1,1	6,1
3,3,1	5,2
3,1,1,1,1	4,3
1,1,1,1,1,1,1	4,2,1

odd	distinct
7,1	8
5,3	7,1
5,1,1,1	6,2
3,3,1,1	5,3
3,1,1,1,1,1	5,2,1
1,1,1,1,1,1,1,1	4,3,1

odd	distinct
9	9
7,1,1	8,1
5,1,1,1	7,2
5,3,1	6,3
3,3,3	6,2,1
3,3,1,1,1	5,4
3,1,1,1,1,1,1	5,3,1
1,1,1,1,1,1,1,1,1	4,3,2

# Matching

From Distinct to Odd.

$$2 \rightarrow 1, 1$$

$$4 \rightarrow 1, 1, 1, 1$$

$$6 \rightarrow 3, 3$$

$$8 \rightarrow 1, 1, 1, 1, 1, 1, 1, 1$$

$$8 \rightarrow 1, 1, 1, 1, 1, 1, 1, 1$$

$$7, 1 \rightarrow 7, 1$$

$$6, 2 \rightarrow 3, 3, 1, 1$$

$$5, 3 \rightarrow 5, 3$$

$$5, 2, 1 \rightarrow 5, 1, 1, 1$$

$$4, 3, 1 \rightarrow 3, 1, 1, 1, 1, 1$$

From Odd to Distinct.

$$1 \rightarrow 1$$

$$1, 1 \rightarrow 2$$

$$1, 1, 1 \rightarrow 2, 1$$

$$1, 1, 1, 1 \rightarrow 4$$

$$1, 1, 1, 1, 1 \rightarrow 4, 1$$

$$1, 1, 1, 1, 1, 1 \rightarrow 4, 2$$

$$1, 1, 1, 1, 1, 1, 1 \rightarrow 4, 2, 1$$

$$1, 1, 1, 1, 1, 1, 1, 1 \rightarrow 8$$

$$1, 1, 1, 1, 1, 1, 1, 1, 1 \rightarrow 8, 1$$

Binary presentation

$$3 = 2^1 + 2^0, \quad 5 = 2^2 + 2^0, \quad 8 = 2^3$$

# Conjugated Partitions

Flip Young diagrams over the diagonal

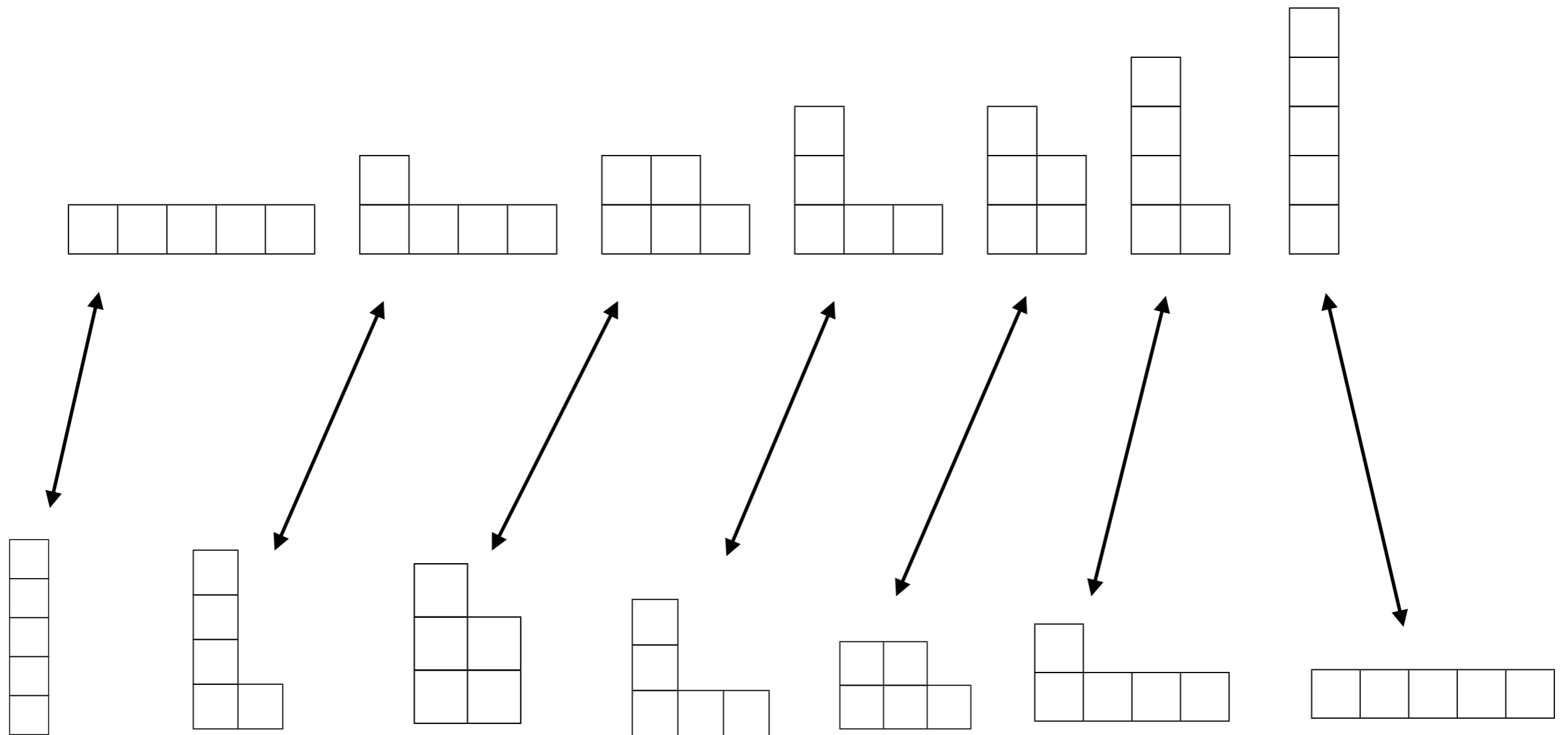

**Problem:** how many self-conjugated (**symmetric**) partitions are there?

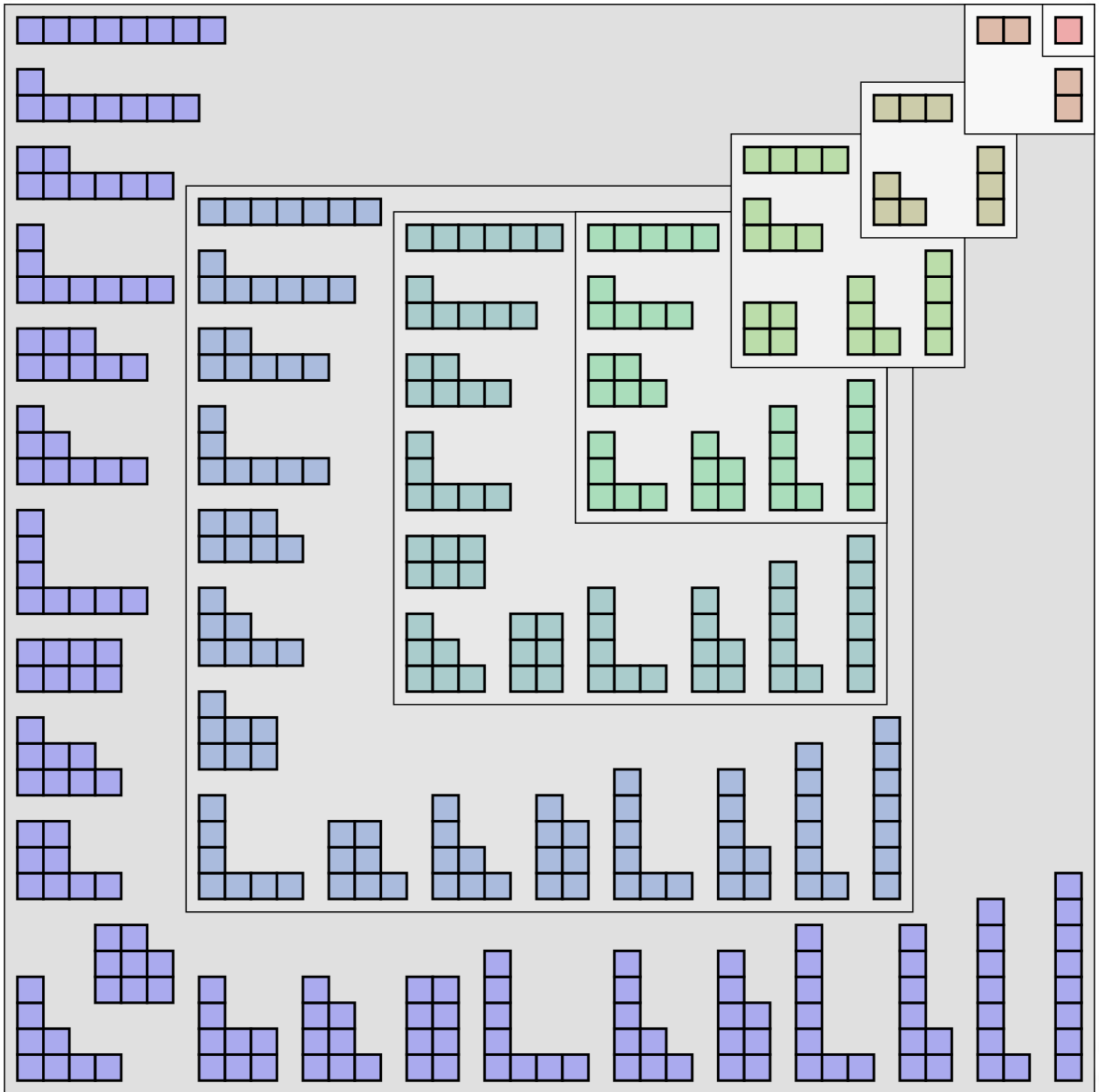

# p(9)

{{**9**}, {8, 1}, {7, 2}, {7, 1, 1}, {6, 3}, {6, 2, 1}, {6, 1, 1, 1}, {5, 4}, {5, 3, 1}, {5, 2, 2},  
{5, 2, 1, 1}, {5, 1, 1, 1, 1}, {4, 4, 1}, {4, 3, 2}, {4, 3, 1, 1}, {4, 2, 2, 1}, {4, 2, 1, 1, 1},  
{4, 1, 1, 1, 1, 1}, {3, 3, 3}, {3, 3, 2, 1}, {3, 3, 1, 1, 1}, {3, 2, 2, 2}, {3, 2, 2, 1, 1},  
{3, 2, 1, 1, 1, 1}, {3, 1, 1, 1, 1, 1, 1}, {2, 2, 2, 2, 1}, {2, 2, 2, 1, 1, 1}, {2, 2, 1, 1, 1, 1, 1},  
{2, 1, 1, 1, 1, 1, 1, 1}, {1, 1, 1, 1, 1, 1, 1, 1, 1}}

# $p(10)$

$\{\{10\}, \{9, 1\}, \{8, 2\}, \{8, 1, 1\}, \{7, 3\}, \{7, 2, 1\}, \{7, 1, 1, 1\}, \{6, 4\}, \{6, 3, 1\}, \{6, 2, 2\}, \{6, 2, 1, 1\}, \{6, 1, 1, 1, 1\}, \{5, 5\}, \{5, 4, 1\}, \{5, 3, 2\}, \{5, 3, 1, 1\}, \{5, 2, 2, 1\}, \{5, 2, 1, 1, 1\}, \{5, 1, 1, 1, 1, 1\}, \{4, 4, 2\}, \{4, 4, 1, 1\}, \{4, 3, 3\}, \{4, 3, 2, 1\}, \{4, 3, 1, 1, 1\}, \{4, 2, 2, 2\}, \{4, 2, 2, 1, 1\}, \{4, 2, 1, 1, 1, 1\}, \{4, 1, 1, 1, 1, 1, 1\}, \{3, 3, 3, 1\}, \{3, 3, 2, 2\}, \{3, 3, 2, 1, 1\}, \{3, 3, 1, 1, 1, 1\}, \{3, 2, 2, 2, 1\}, \{3, 2, 2, 1, 1, 1\}, \{3, 2, 1, 1, 1, 1, 1\}, \{3, 1, 1, 1, 1, 1, 1, 1\}, \{2, 2, 2, 2, 2\}, \{2, 2, 2, 2, 1, 1\}, \{2, 2, 2, 1, 1, 1, 1\}, \{2, 2, 1, 1, 1, 1, 1, 1\}, \{2, 1, 1, 1, 1, 1, 1, 1, 1\}, \{1, 1, 1, 1, 1, 1, 1, 1, 1, 1\}\}$





# $p(11)$

$\{\{11\}, \{10, 1\}, \{9, 2\}, \{9, 1, 1\}, \{8, 3\}, \{8, 2, 1\}, \{8, 1, 1, 1\}, \{7, 4\}, \{7, 3, 1\}, \{7, 2, 2\}, \{7, 2, 1, 1\}, \{7, 1, 1, 1, 1\}, \{6, 5\}, \{6, 4, 1\}, \{6, 3, 2\}, \{6, 3, 1, 1\}, \{6, 2, 2, 1\}, \{6, 2, 1, 1, 1\}, \{6, 1, 1, 1, 1, 1\}, \{5, 5, 1\}, \{5, 4, 2\}, \{5, 4, 1, 1\}, \{5, 3, 3\}, \{5, 3, 2, 1\}, \{5, 3, 1, 1, 1\}, \{5, 2, 2, 2\}, \{5, 2, 2, 1, 1\}, \{5, 2, 1, 1, 1, 1\}, \{5, 1, 1, 1, 1, 1, 1\}, \{4, 4, 3\}, \{4, 4, 2, 1\}, \{4, 4, 1, 1, 1\}, \{4, 3, 3, 1\}, \{4, 3, 2, 2\}, \{4, 3, 2, 1, 1\}, \{4, 3, 1, 1, 1, 1\}, \{4, 2, 2, 2, 1\}, \{4, 2, 2, 1, 1, 1\}, \{4, 2, 1, 1, 1, 1, 1\}, \{4, 1, 1, 1, 1, 1, 1, 1\}, \{3, 3, 3, 2\}, \{3, 3, 3, 1, 1\}, \{3, 3, 2, 2, 1\}, \{3, 3, 2, 1, 1, 1\}, \{3, 3, 1, 1, 1, 1, 1\}, \{3, 2, 2, 2, 2\}, \{3, 2, 2, 2, 1, 1\}, \{3, 2, 2, 1, 1, 1, 1\}, \{3, 2, 1, 1, 1, 1, 1, 1\}, \{3, 1, 1, 1, 1, 1, 1, 1, 1\}, \{2, 2, 2, 2, 2, 1\}, \{2, 2, 2, 2, 1, 1, 1\}, \{2, 2, 2, 1, 1, 1, 1, 1\}, \{2, 2, 1, 1, 1, 1, 1, 1, 1\}, \{2, 1, 1, 1, 1, 1, 1, 1, 1, 1\}, \{1, 1, 1, 1, 1, 1, 1, 1, 1, 1, 1\}\}$

# Odd, Distinct, Symmetric

n	1	2	3	4	5	6	7	8	9	10	11	12
p(n)	1	2	3	5	7	11	15	22	30	42	56	77
# odd	1	1	2	2	3	4	5	6	8	10	12	15
# distinct	1	1	2	2	3	4	5	6	8	10	12	15
# symmetric	1	0	1	1	1	1	1	2	2	2	2	3
# odd&distinct	1	0	1	1	1	1	1	2	2	2	2	3

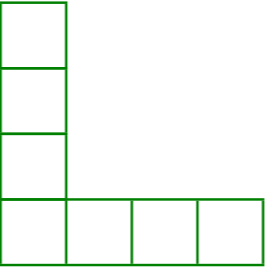
**Problem:** Show that **Symmetric** = **Odd&Distinct**

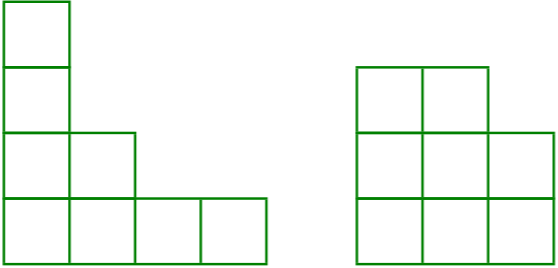
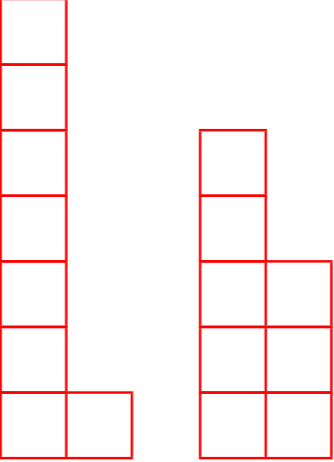
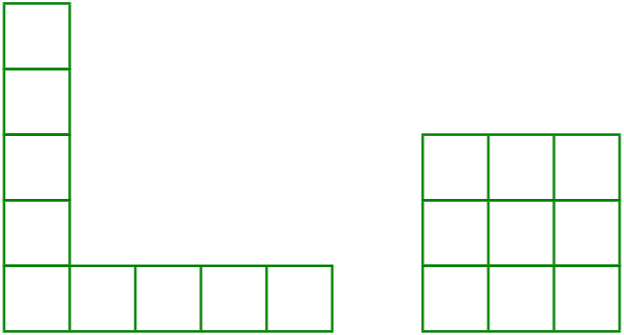
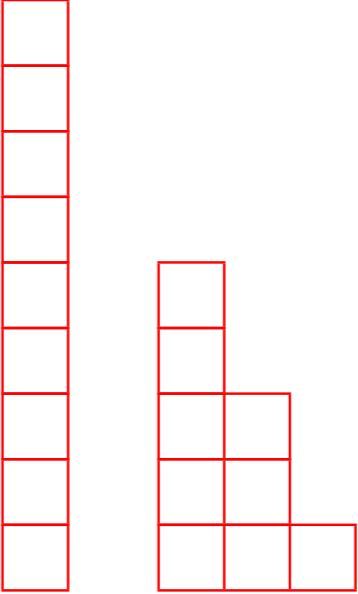
n	Symmetric	Odd&Distinct
7		
8		
9		

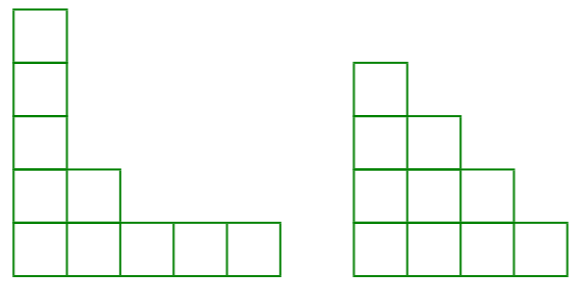
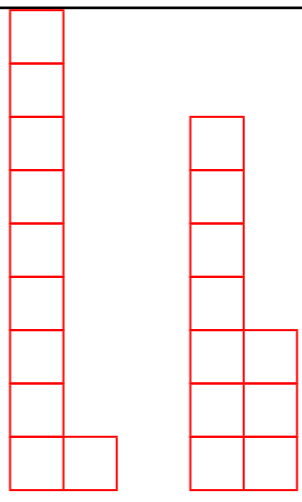
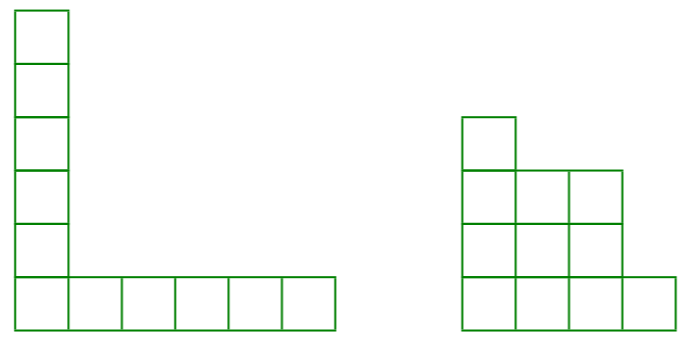
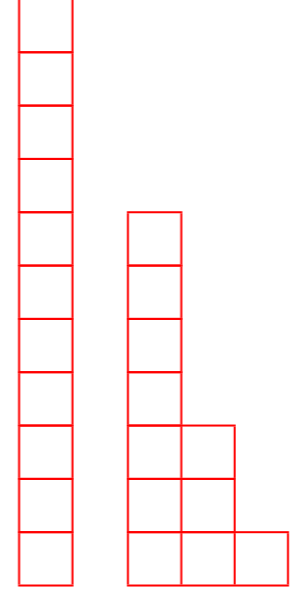
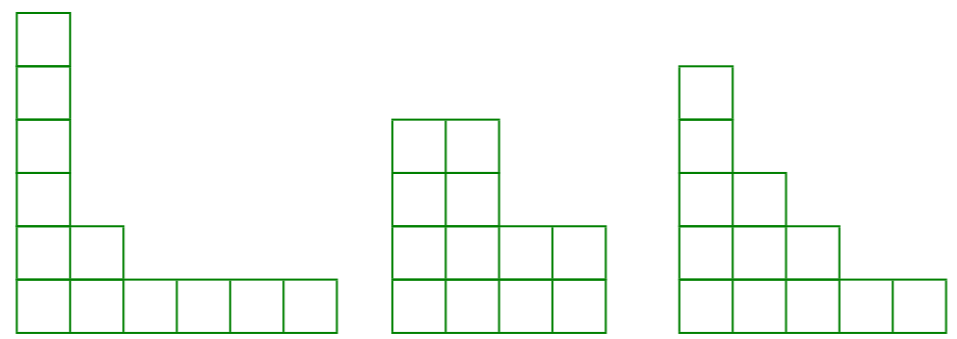
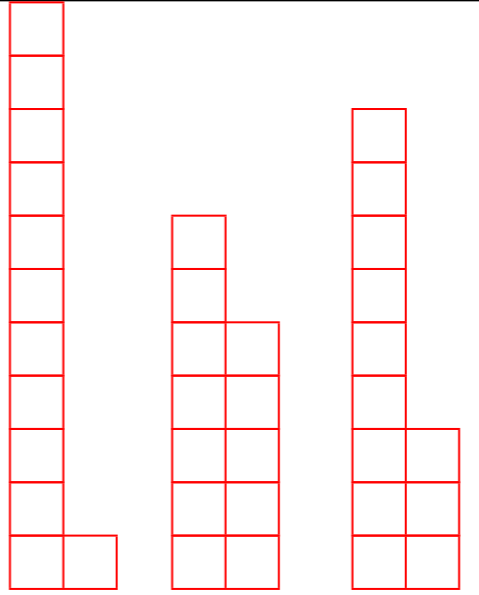
10		
11		
12		

# Matching

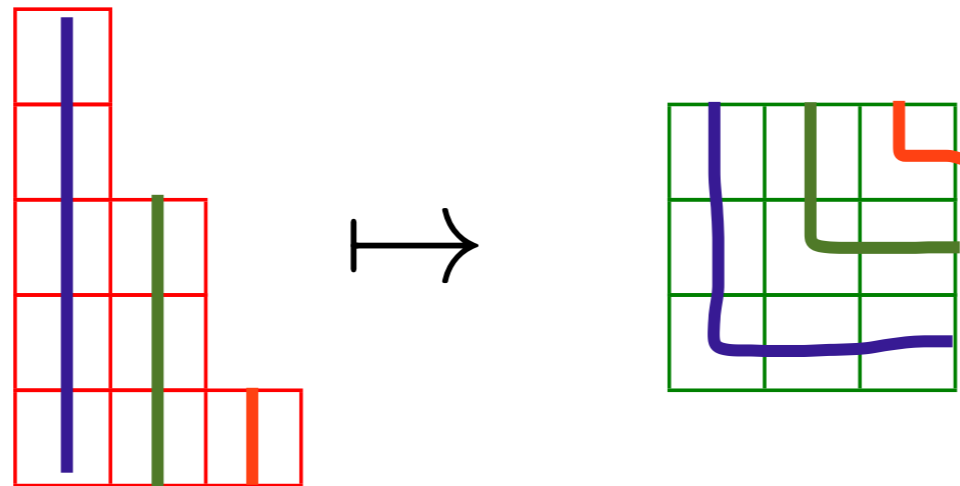

# Odd&Distinct vs Symmetric Triangular numbers

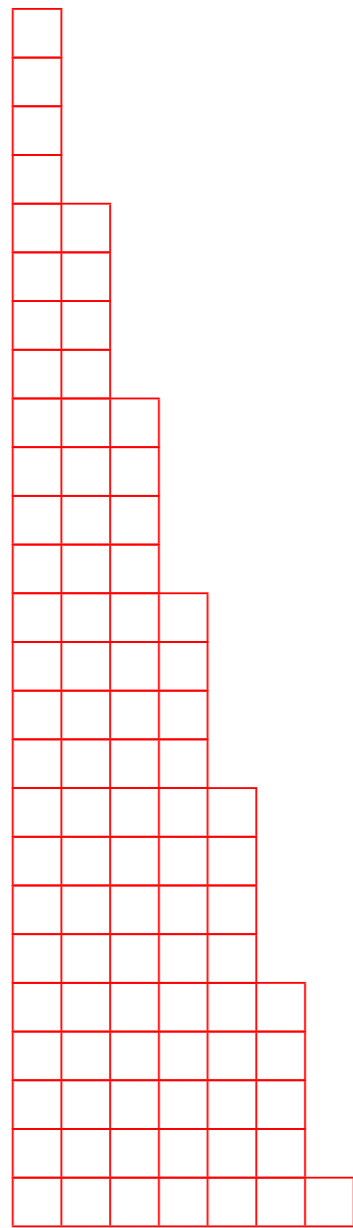

{25,21,17,13,9,5,1}

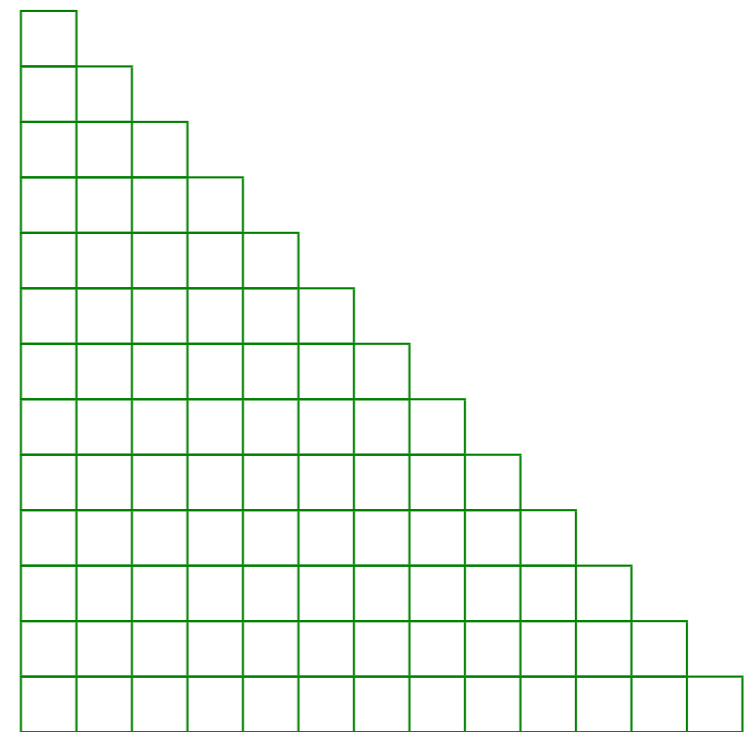

{13,12,11,10,9,8,7,6,5,4,3,2,1}

# Odd&Distinct vs Symmetric Square numbers

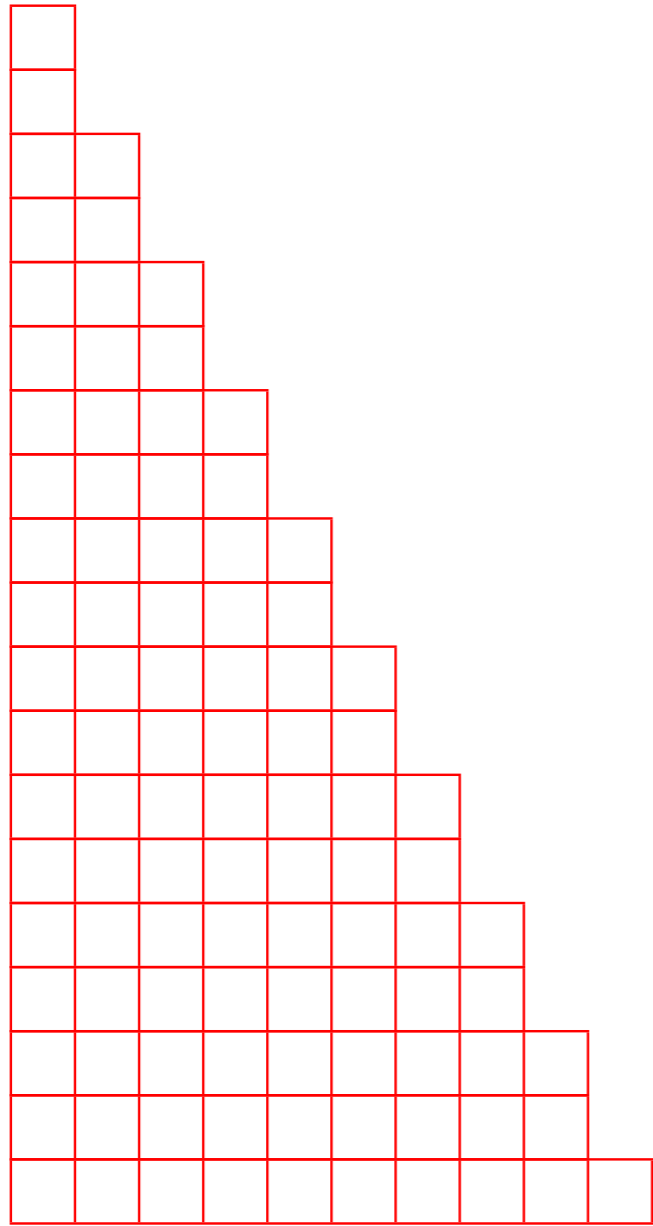

{19, 17, 15, 13, 11, 9, 7, 5, 3, 1}

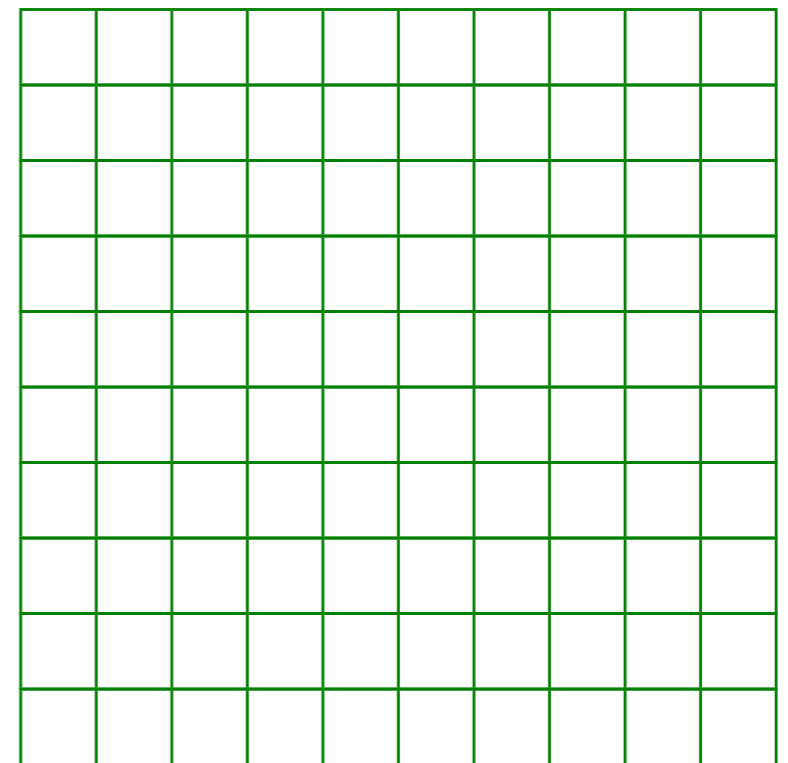

{10, 10, 10, 10, 10, 10, 10, 10, 10, 10}

# Computing Sums

Compute the sum. How many terms are in the sum?



$$1 + 3 + 5 + \dots + 117 + 119 = ?$$



$$1 + 5 + 9 + 13 + 17 + 21 + 25 = ?$$



$$1 + 5 + 9 + 13 + \dots + 81 = ?$$



# Divisibility by 3

Consider partitions of  $n$  whose parts are not divisible by 3

Compare those with partitions of  $n$  in which **each part** is not repeated 3 or more times

# Divisibility by 4

Consider partitions of  $n$  whose parts are not divisible by 4

Compare those with partitions of  $n$  in which **each part** is not repeated 4 or more times

# Divisibility by $n$

Consider partitions of  $n$  whose parts are not divisible by  $n$

Compare those with partitions of  $n$  in which **each part** is not repeated  $n$  or more times

# Restricted Partitions

**Restricted Partitions.** Let us now look at integer partitions of  $n$  which are not allowed to have more than  $k$  parts. For instance, let  $n = 7$  and  $k = 4$ . Then we shall only look at partitions which have *exactly* 4 parts. From the list of partitions of 7

$\{\{7\}, \{6, 1\}, \{5, 2\}, \{5, 1, 1\}, \{4, 3\}, \{4, 2, 1\}, \{4, 1, 1, 1\}, \{3, 3, 1\}, \{3, 2, 2\},$   
 $\{3, 2, 1, 1\}, \{3, 1, 1, 1, 1\}, \{2, 2, 2, 1\}, \{2, 2, 1, 1, 1\}, \{2, 1, 1, 1, 1, 1\}, \{1, 1, 1, 1, 1, 1, 1\}\}$

Only these qualify

$\{\{4, 1, 1, 1\}, \{3, 2, 1, 1\}, \{2, 2, 2, 1\}\}$

Make lists for  $n = 4, 5, 6$  with all possible restricted parts, i.e. all partitions of 4 with 1, with 2, with 3 parts, etc., same for  $n = 5$  and  $n = 6$ . Count each number of partitions, call it  $p_k(n)$ . Do you see any pattern?

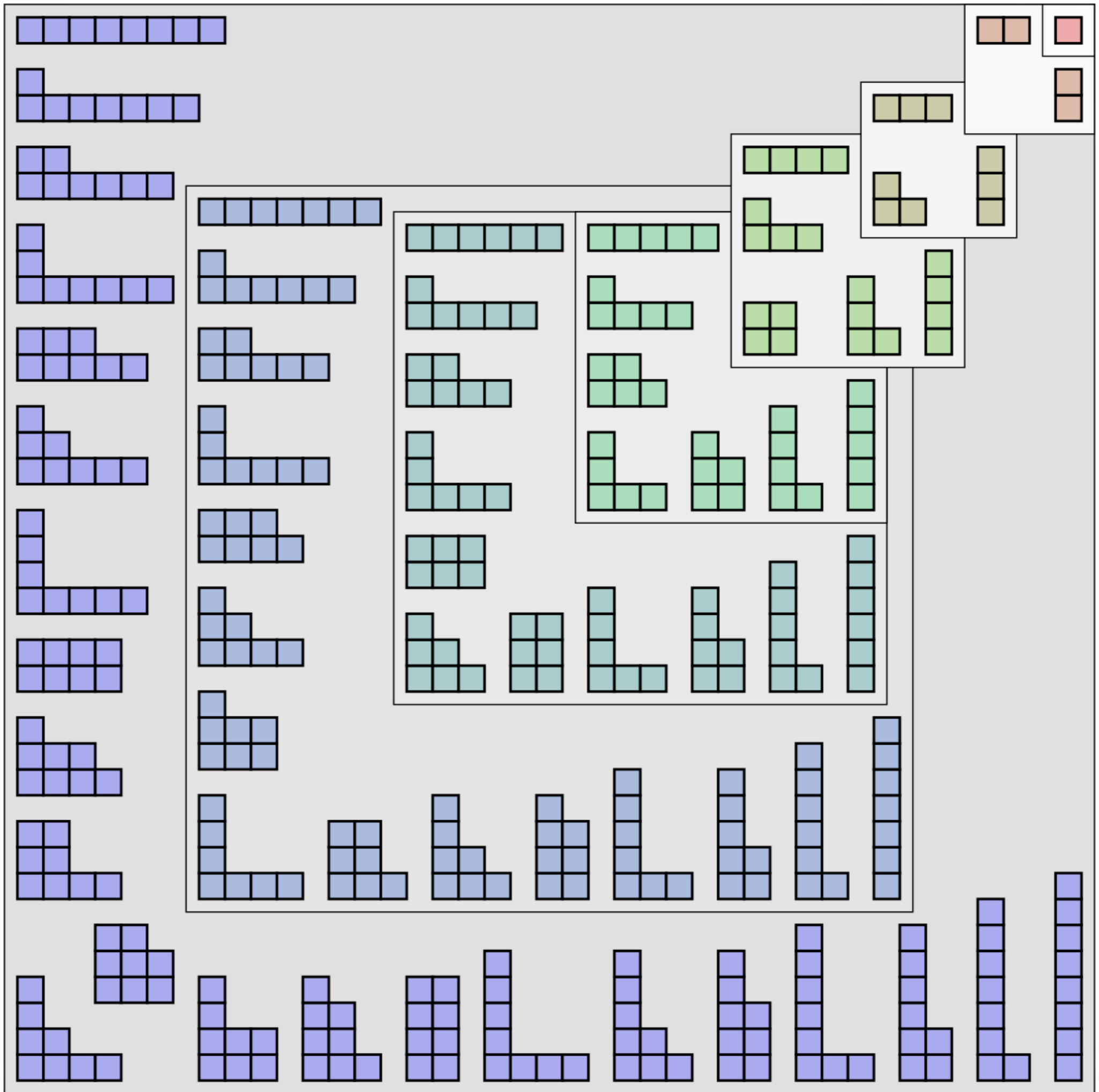

	1	2	3	4	5	6	7	8
p(1)	1							
p(2)	1	1						
p(3)	1	1	1					
p(4)	1	2	1	1				
p(5)	1	2	2	1	1			
p(6)	1	3	3	2	1	1		
p(7)	1	3	4	3	2	1	1	
p(8)	1	4	5	5	3	2	1	1

# $p(9)$

$\{\{9\}, \{8, 1\}, \{7, 2\}, \{7, 1, 1\}, \{6, 3\}, \{6, 2, 1\}, \{6, 1, 1, 1\}, \{5, 4\}, \{5, 3, 1\}, \{5, 2, 2\},$   
 $\{5, 2, 1, 1\}, \{5, 1, 1, 1, 1\}, \{4, 4, 1\}, \{4, 3, 2\}, \{4, 3, 1, 1\}, \{4, 2, 2, 1\}, \{4, 2, 1, 1, 1\},$   
 $\{4, 1, 1, 1, 1, 1\}, \{3, 3, 3\}, \{3, 3, 2, 1\}, \{3, 3, 1, 1, 1\}, \{3, 2, 2, 2\}, \{3, 2, 2, 1, 1\},$   
 $\{3, 2, 1, 1, 1, 1\}, \{3, 1, 1, 1, 1, 1, 1\}, \{2, 2, 2, 2, 1\}, \{2, 2, 2, 1, 1, 1\}, \{2, 2, 1, 1, 1, 1, 1\},$   
 $\{2, 1, 1, 1, 1, 1, 1, 1\}, \{1, 1, 1, 1, 1, 1, 1, 1, 1\}\}$

# $p(10)$

$\{\{10\}, \{9, 1\}, \{8, 2\}, \{8, 1, 1\}, \{7, 3\}, \{7, 2, 1\}, \{7, 1, 1, 1\}, \{6, 4\}, \{6, 3, 1\}, \{6, 2, 2\}, \{6, 2, 1, 1\}, \{6, 1, 1, 1, 1\}, \{5, 5\}, \{5, 4, 1\}, \{5, 3, 2\}, \{5, 3, 1, 1\}, \{5, 2, 2, 1\}, \{5, 2, 1, 1, 1\}, \{5, 1, 1, 1, 1, 1\}, \{4, 4, 2\}, \{4, 4, 1, 1\}, \{4, 3, 3\}, \{4, 3, 2, 1\}, \{4, 3, 1, 1, 1\}, \{4, 2, 2, 2\}, \{4, 2, 2, 1, 1\}, \{4, 2, 1, 1, 1, 1\}, \{4, 1, 1, 1, 1, 1, 1\}, \{3, 3, 3, 1\}, \{3, 3, 2, 2\}, \{3, 3, 2, 1, 1\}, \{3, 3, 1, 1, 1, 1\}, \{3, 2, 2, 2, 1\}, \{3, 2, 2, 1, 1, 1\}, \{3, 2, 1, 1, 1, 1, 1\}, \{3, 1, 1, 1, 1, 1, 1, 1\}, \{2, 2, 2, 2, 2\}, \{2, 2, 2, 2, 1, 1\}, \{2, 2, 2, 1, 1, 1, 1\}, \{2, 2, 1, 1, 1, 1, 1, 1\}, \{2, 1, 1, 1, 1, 1, 1, 1, 1\}, \{1, 1, 1, 1, 1, 1, 1, 1, 1, 1\}\}$



# $p(11)$

$\{\{11\}, \{10, 1\}, \{9, 2\}, \{9, 1, 1\}, \{8, 3\}, \{8, 2, 1\}, \{8, 1, 1, 1\}, \{7, 4\}, \{7, 3, 1\}, \{7, 2, 2\}, \{7, 2, 1, 1\}, \{7, 1, 1, 1, 1\}, \{6, 5\}, \{6, 4, 1\}, \{6, 3, 2\}, \{6, 3, 1, 1\}, \{6, 2, 2, 1\}, \{6, 2, 1, 1, 1\}, \{6, 1, 1, 1, 1, 1\}, \{5, 5, 1\}, \{5, 4, 2\}, \{5, 4, 1, 1\}, \{5, 3, 3\}, \{5, 3, 2, 1\}, \{5, 3, 1, 1, 1\}, \{5, 2, 2, 2\}, \{5, 2, 2, 1, 1\}, \{5, 2, 1, 1, 1, 1\}, \{5, 1, 1, 1, 1, 1, 1\}, \{4, 4, 3\}, \{4, 4, 2, 1\}, \{4, 4, 1, 1, 1\}, \{4, 3, 3, 1\}, \{4, 3, 2, 2\}, \{4, 3, 2, 1, 1\}, \{4, 3, 1, 1, 1, 1\}, \{4, 2, 2, 2, 1\}, \{4, 2, 2, 1, 1, 1\}, \{4, 2, 1, 1, 1, 1, 1\}, \{4, 1, 1, 1, 1, 1, 1, 1\}, \{3, 3, 3, 2\}, \{3, 3, 3, 1, 1\}, \{3, 3, 2, 2, 1\}, \{3, 3, 2, 1, 1, 1\}, \{3, 3, 1, 1, 1, 1, 1\}, \{3, 2, 2, 2, 2\}, \{3, 2, 2, 2, 1, 1\}, \{3, 2, 2, 1, 1, 1, 1\}, \{3, 2, 1, 1, 1, 1, 1, 1\}, \{3, 1, 1, 1, 1, 1, 1, 1, 1\}, \{2, 2, 2, 2, 2, 1\}, \{2, 2, 2, 2, 1, 1, 1\}, \{2, 2, 2, 1, 1, 1, 1, 1\}, \{2, 2, 1, 1, 1, 1, 1, 1, 1\}, \{2, 1, 1, 1, 1, 1, 1, 1, 1, 1\}, \{1, 1, 1, 1, 1, 1, 1, 1, 1, 1, 1\}\}$



# Recurrent Formula

$$p_k(n) = p_{k-1}(n-1) + p_k(n-k)$$

$$p_3(9) = p_2(8) + p_3(6)$$

7

4

3

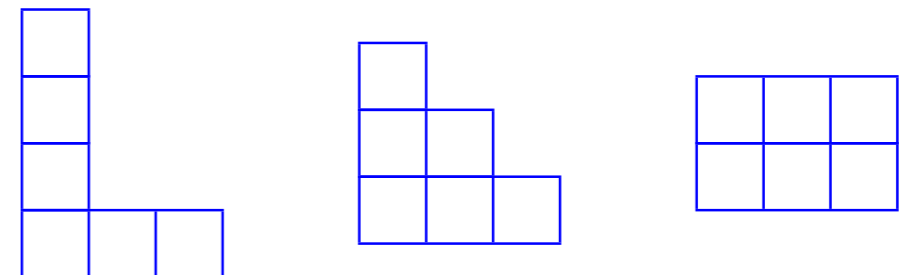
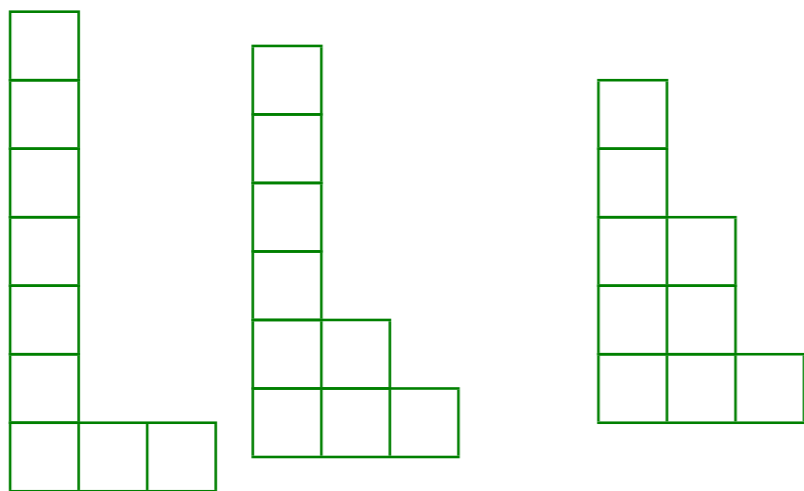
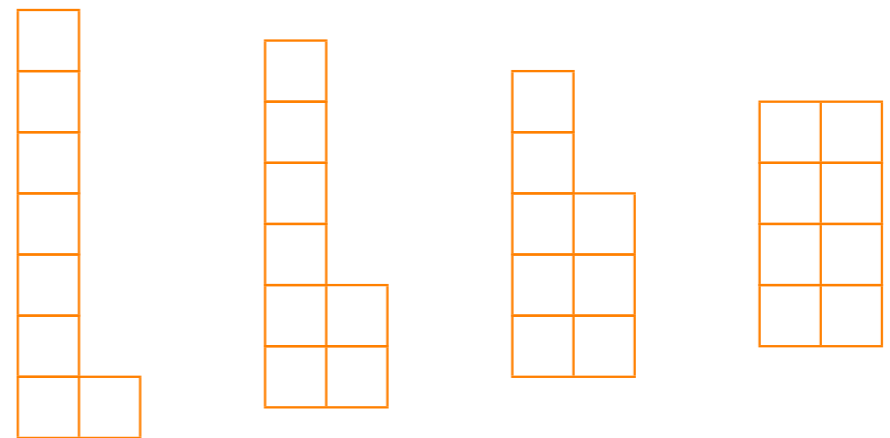
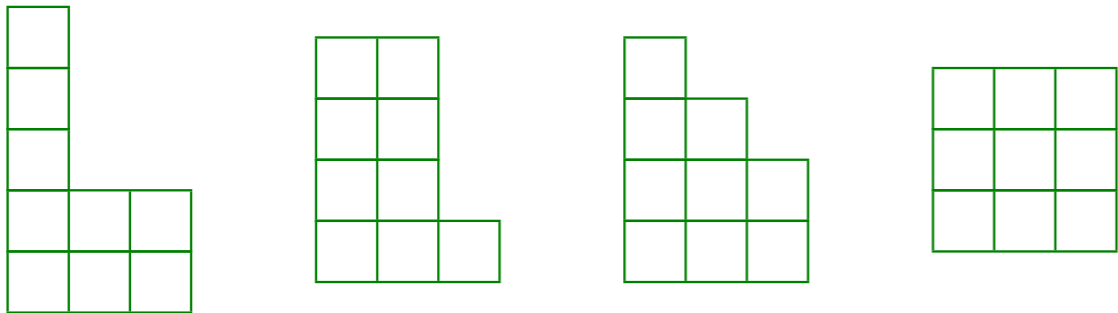

# Matching

$$p_k(n) = p_{k-1}(n-1) + p_k(n-k)$$

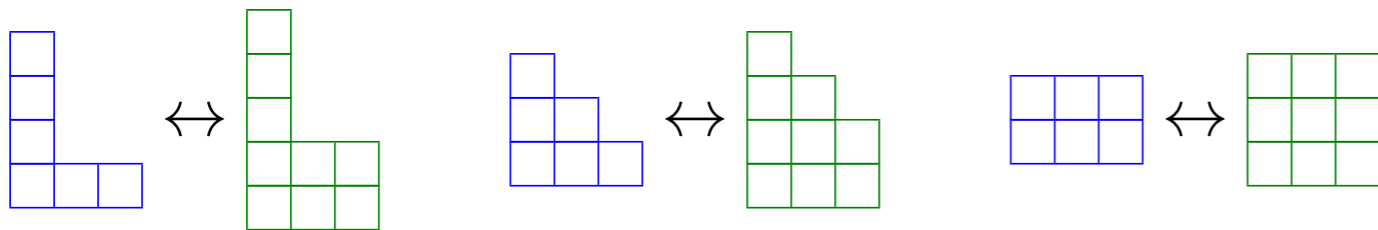
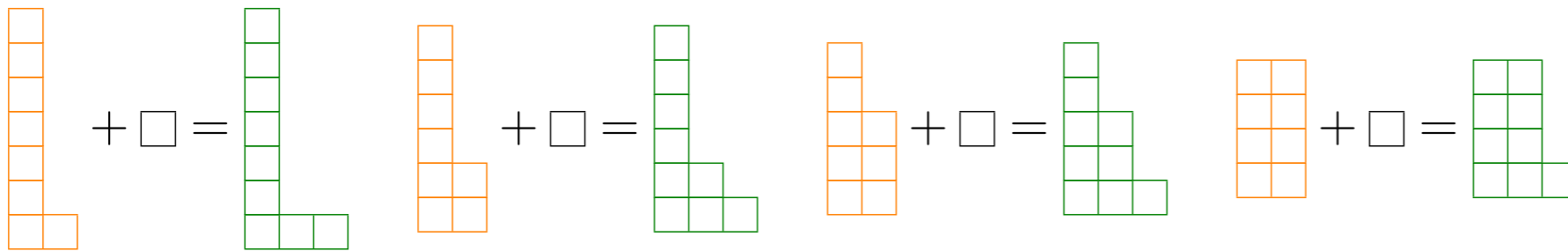

# Understanding $p(n)$

n	1	2	3	4	5	6	7	8	9	10	11	12
$p(n)$	1	2	3	5	7	11	15	22	30	42	56	77
# odd	1	1	2	2	3	4	5	6	8	10	12	15
# distinct	1	1	2	2	3	4	5	6	8	10	12	15
# symmetric	1	0	1	1	1	1	1	2	2	2	2	3
# odd&distinct	1	0	1	1	1	1	1	2	2	2	2	3

# Odd and Even Number of parts

For each  $n$  count *distinct partitions* with **odd** and **even** number of parts

$n=8$

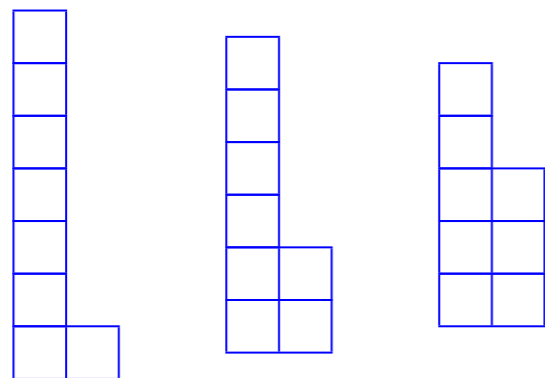
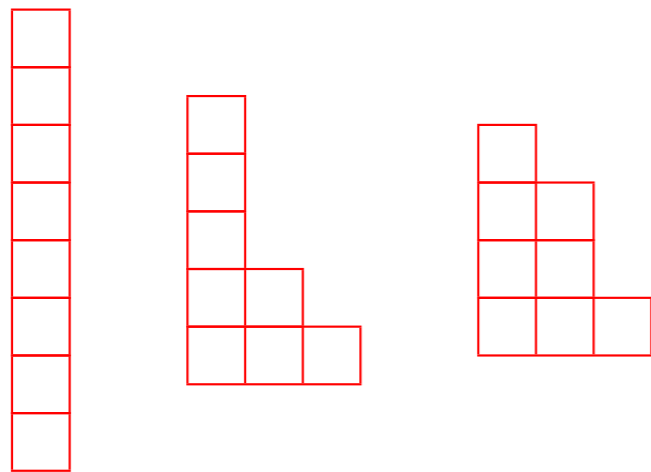

$n=9$

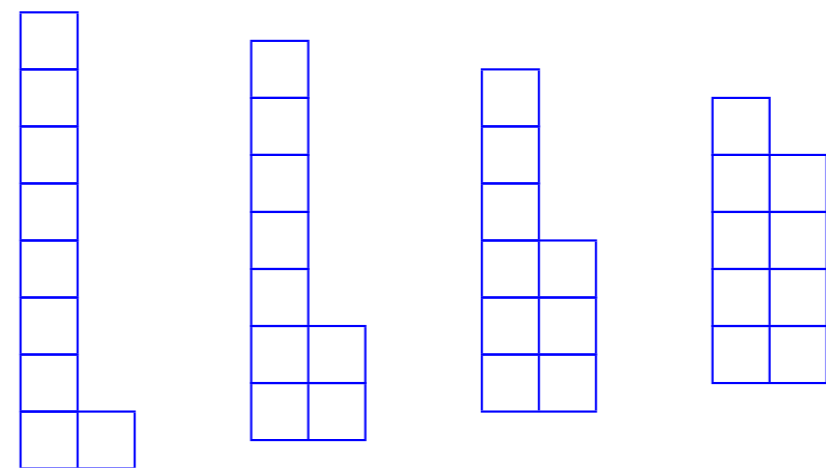
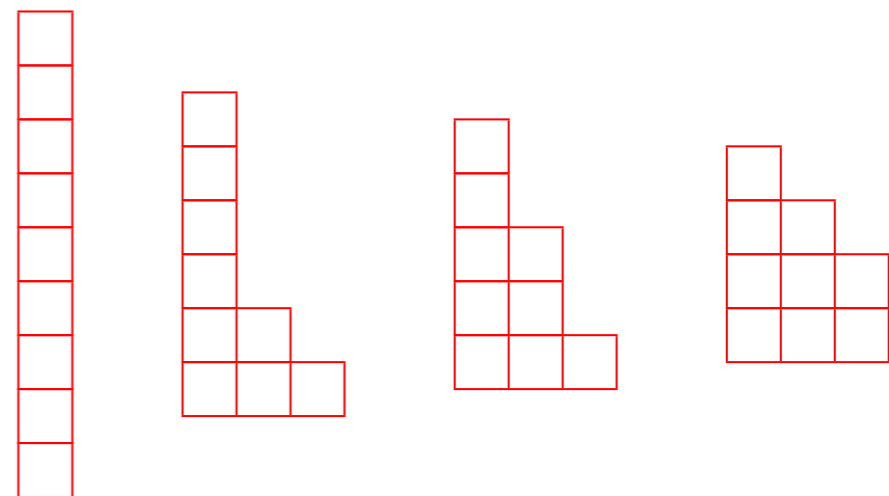

**n=10**

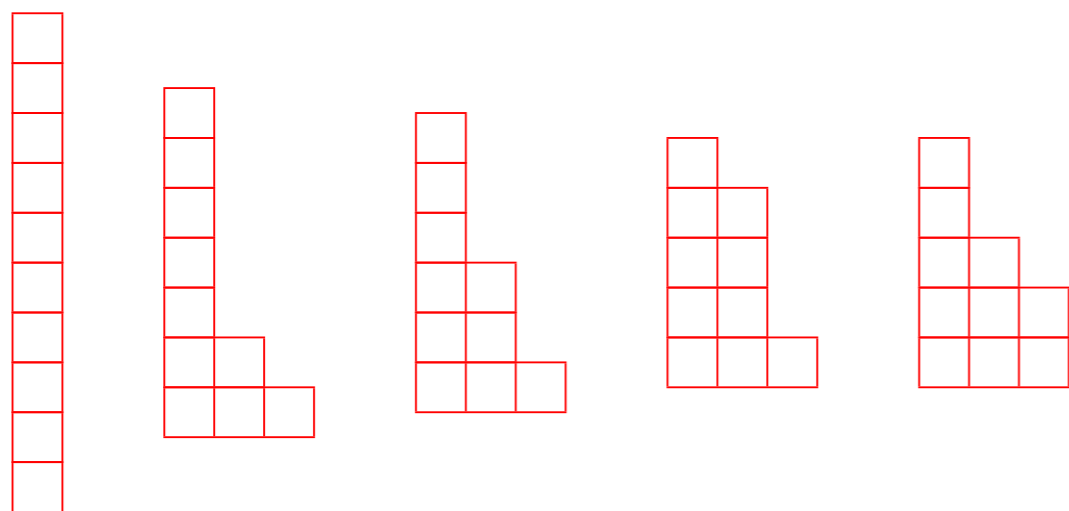

**n=11**

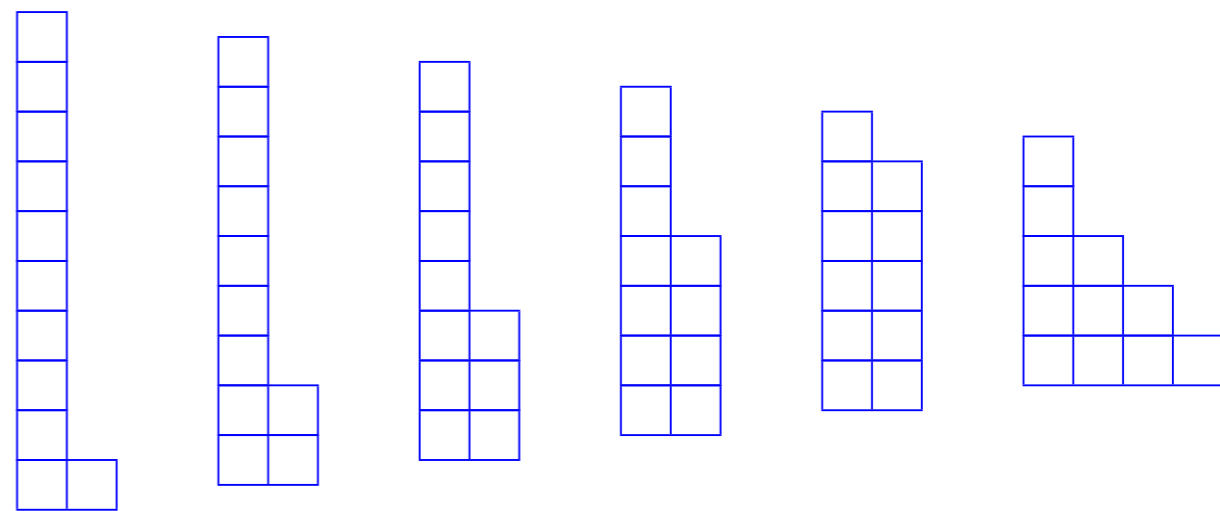
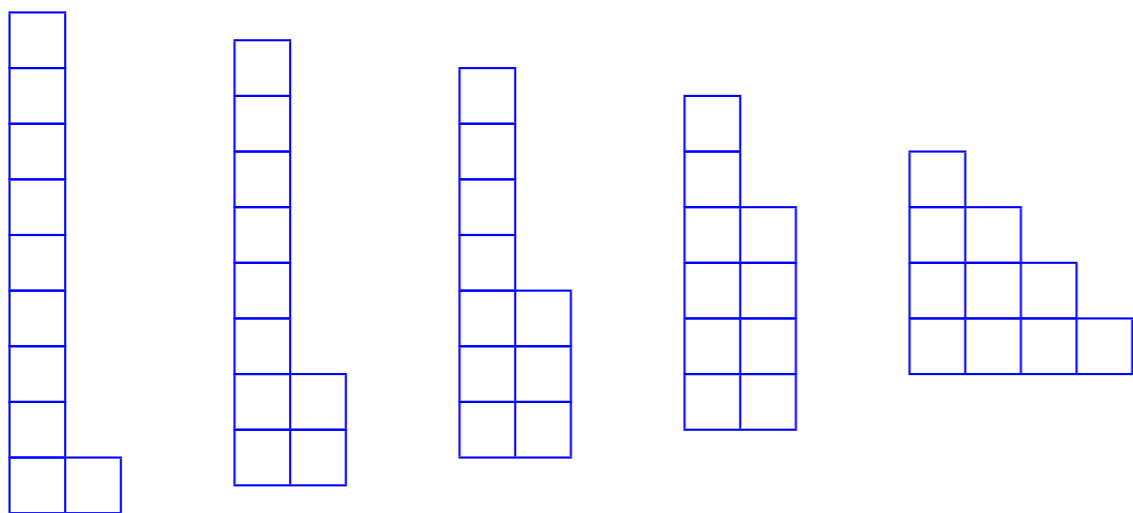
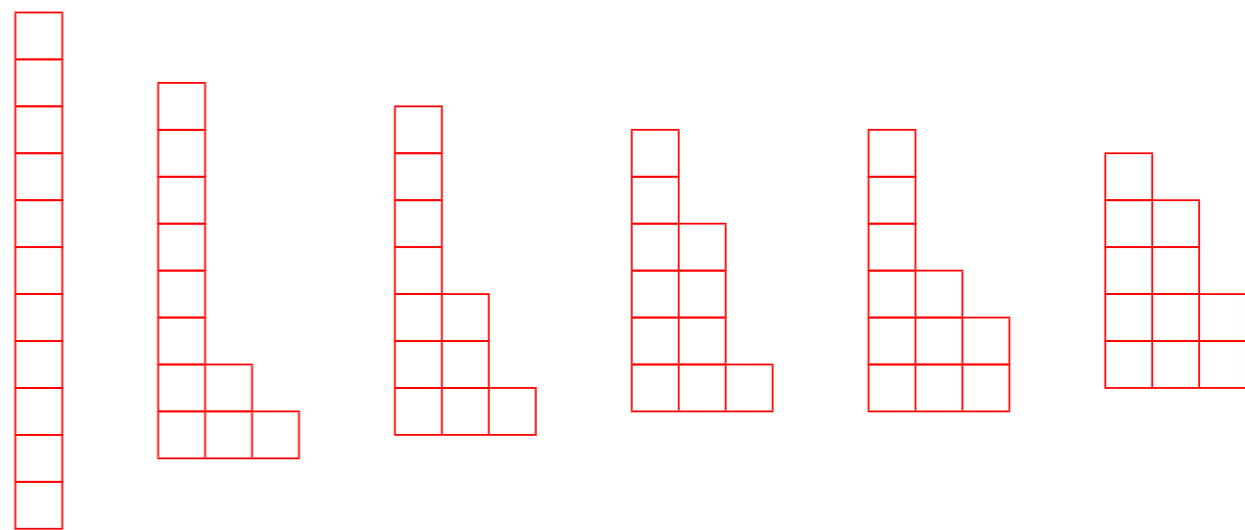

# Matching

n=8

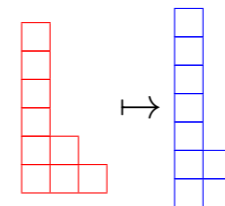
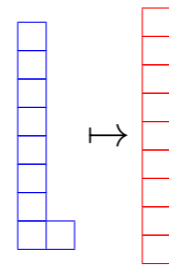
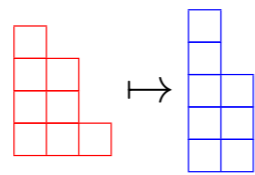
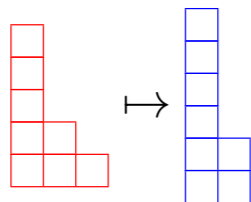
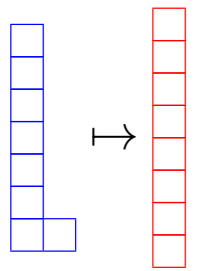

n=9

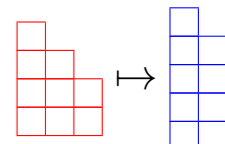
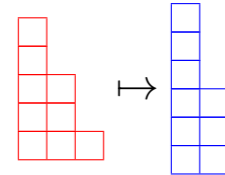

n=10

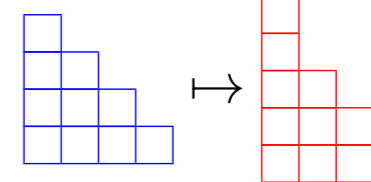
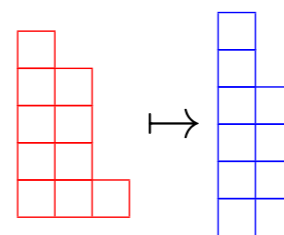
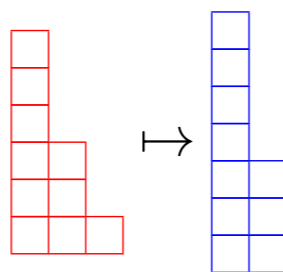
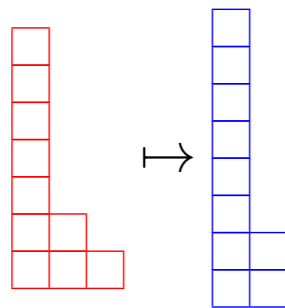
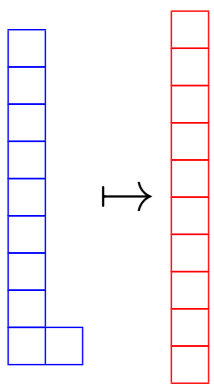



**n=12**

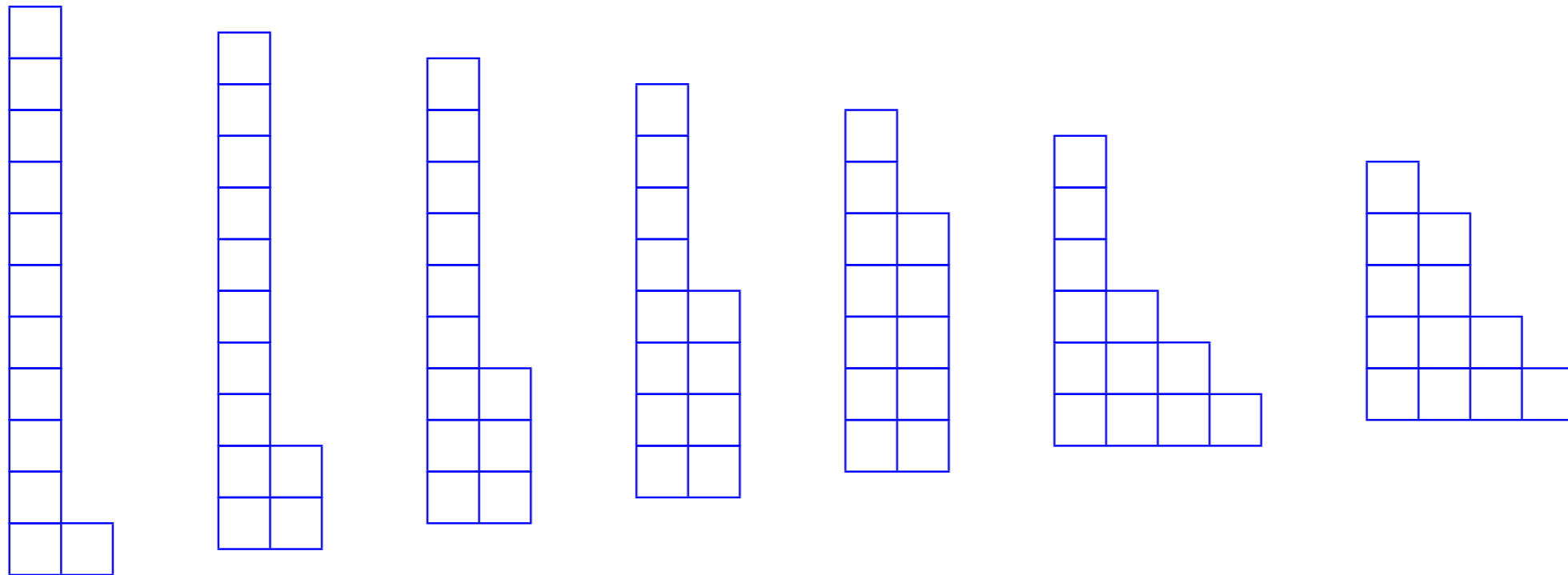
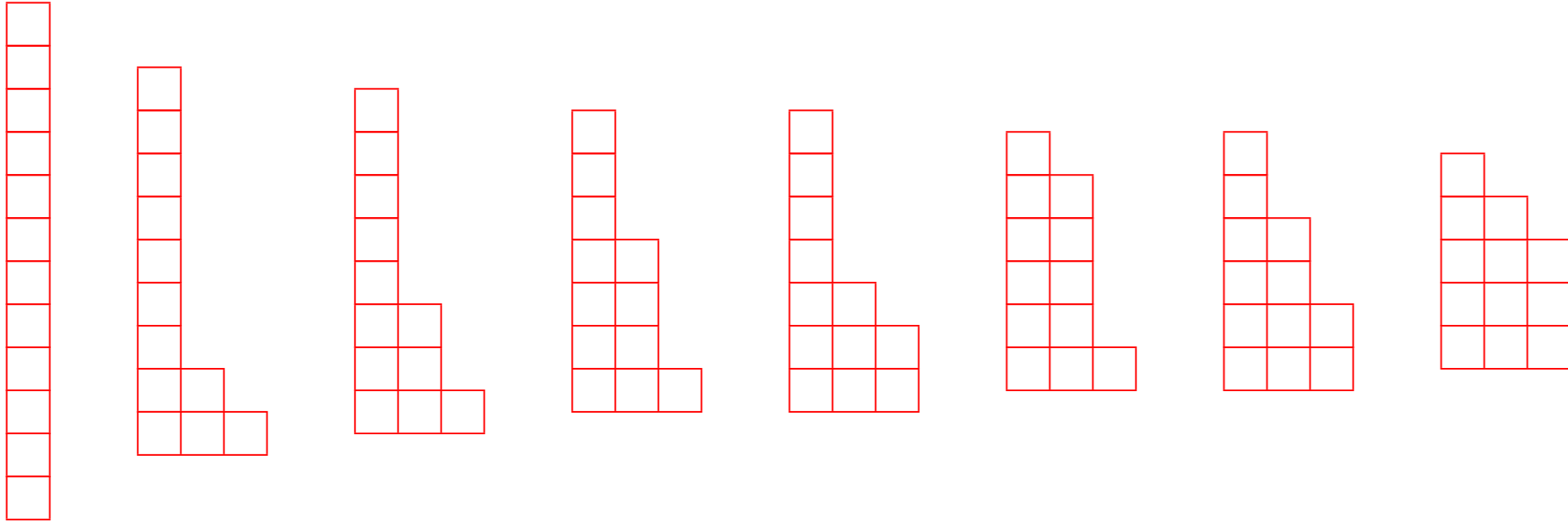

# Pentagonal Numbers

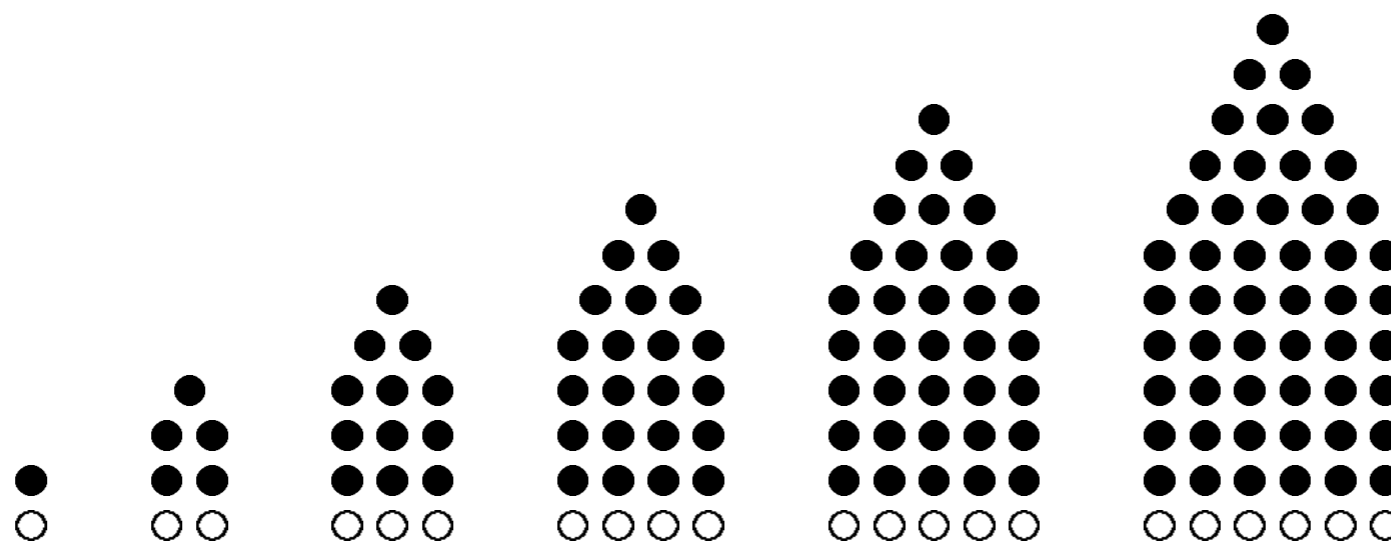
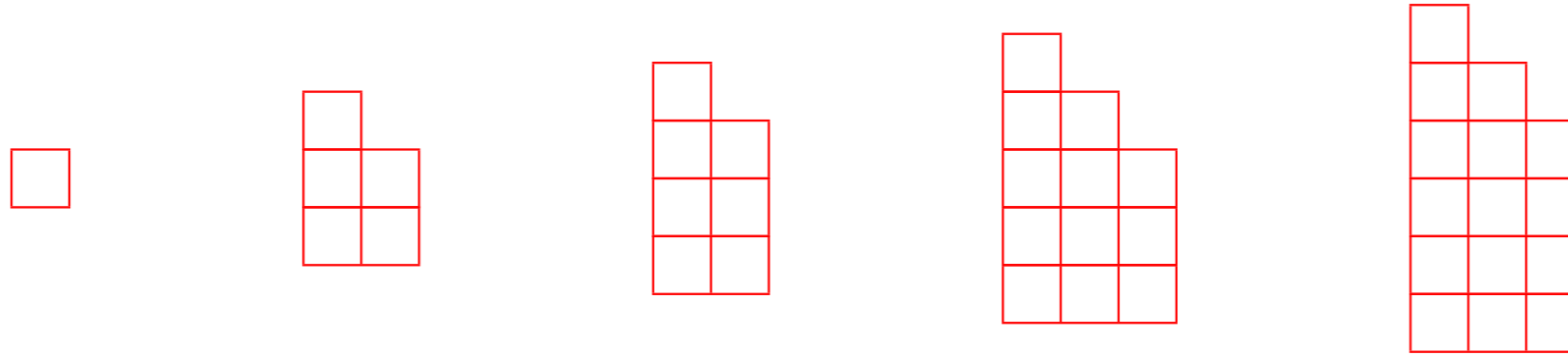

*1,2*

*5,7*

*12,15*

*22,26*

*35,40*

*51,57*

# Pentagonal Numbers

$n$	-8	-7	-6	-5	-4	-3	-2	-1	0	1	2	3	4	5	6	7	8
$T_n$	28	21	15	10	6	3	1	0	0	1	3	6	10	15	21	28	36
$S_n$	64	49	36	25	16	9	4	1	0	1	4	9	16	25	36	49	64
$P_n$	100	77	57	40	26	15	7	2	0	1	5	12	22	35	51	70	92

1,2, 5,7, 12,15, 22,26, 35,40, 51,57, 70,77, 92,100,

# Pentagonal Numbers

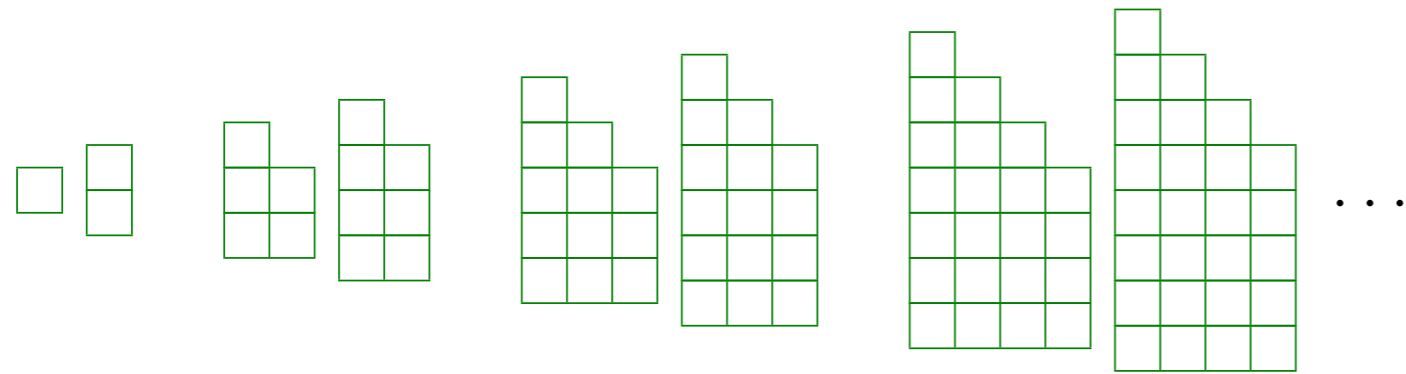

Show that  $P_n = \frac{n(3n-1)}{2}$

$(P_1, P_{-1}) \quad (P_2, P_{-2}) \quad (P_3, P_{-3}) \quad (P_4, P_{-4}) \quad \dots$

**Theorem:** If  $n$  is not a pentagonal number, then the number of even distinct partitions of  $n$ , call it  $q_e(n)$  equals the number of odd distinct partitions of  $n$ , call it  $q_o(n)$ . So  $q_e(n) = q_o(n)$  and so the total number of distinct partitions of  $n$ , call it  $q(n)$  is  $q(n) = 2q_o(n)$  which is even.

If  $n$  is a pentagonal number, say  $n = P_j$ , then  $q_e(n) = q_o(n) + (-1)^j$  and so  $q(n) = 2q_o(n) + (-1)^j$  which is odd.

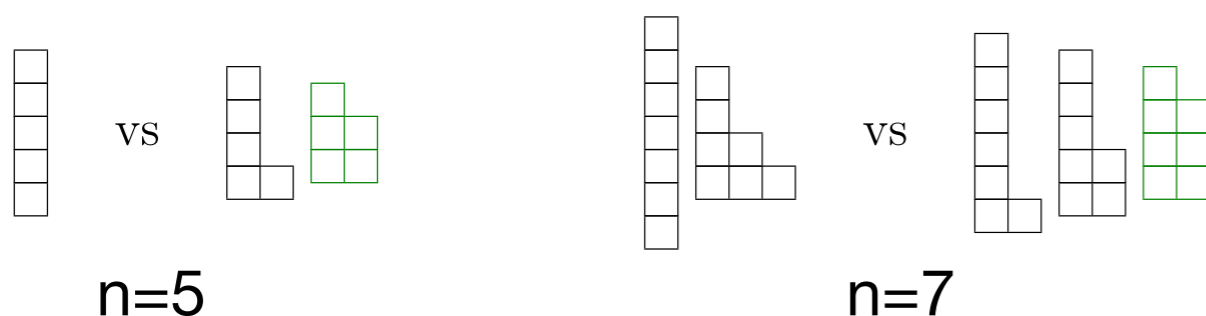

# Generating Function for Partitions

$$(1-z)(1-z^2) = 1 \times (1-z^2) - z \times (1-z^2) = 1 \times 1 - 1 \times z^2 - z \times 1 - z \times (-z^2) = 1 - z - z^2 + z^3$$

$$\begin{aligned} (1-z)(1-z^2)(1-z^3) &= (1-z-z^2+z^3)(1-z^3) = (1-z-z^2+z^3-z^3)1 + (1-z-z^2+z^3)(-z^3) \\ &= 1 - z - z^2 + z^3 - z^3 - z^3 + z^4 + z^5 - z^6 = 1 - z - z^2 + z^4 + z^5 - z^6 \end{aligned}$$

$$\phi(z) = \prod_{k=1}^{\infty} (1 - z^k) = (1 - z)(1 - z^2)(1 - z^3)(1 - z^4) \cdot \dots$$

$$\phi(z) = 1 - z^1 - z^2 + z^5 + z^7 - z^{12} - z^{15} + z^{22} + z^{26} - \dots$$

coefficient for  $z^n$  equals: #distinct even partitions of  $n$   
 -#distinct odd partitions of  $n$

$$\mathbf{p}(z) = \frac{1}{\phi(z)} = \prod_{k=1}^{\infty} \frac{1}{1 - z^k} = \frac{1}{(1 - z)(1 - z^2)(1 - z^3)(1 - z^4) \cdot \dots}$$

Recall that

$$\frac{1}{1-z} = 1 + z + z^2 + z^3 + z^4 + \dots$$

so

$$\frac{1}{1-z^k} = 1 + z^k + z^{2k} + z^{3k} + z^{4k} + \dots$$

Generating function

$$\mathbf{p}(z) = \frac{1}{\phi(z)} = \prod_{k=1}^{\infty} \frac{1}{1-z^k} = \frac{1}{(1-z)(1-z^2)(1-z^3)(1-z^4) \cdot \dots}$$

$$\mathbf{p}(z) = (1 + z + z^2 + z^3 + \dots)(1 + z^2 + z^4 + z^6 + \dots)(1 + z^3 + z^6 + z^9 + \dots) \cdot \dots$$

$$\mathbf{p}(z) = \prod_{k=1}^{\infty} (1 + z^k + z^{2k} + z^{3k} + \dots)$$

$$\mathbf{p}(z) = (1 + z + z^2 + z^3 + \dots)(1 + z^2 + z^4 + z^6 + \dots)(1 + z^3 + z^6 + z^9 + \dots) \cdot \dots$$

Now we need to collect terms in front of each power of  $z$ . Each term  $z^n$  in the resulting product will look like

$$z^{k_1} \cdot z^{2k_2} \cdot z^{3k_3} \cdot \dots \cdot z^{mk_m} = z^{k_1 + 2k_2 + 3k_3 + \dots + mk_m}$$

We want to count the number of such products with  $k_1 + 2k_2 + 3k_3 + \dots + mk_m = n$

$$n = k_1 + 2k_2 + \dots + mk_m = \underbrace{1 + \dots + 1}_{k_1} + \underbrace{2 + \dots + 2}_{k_2} + \dots + \underbrace{m + \dots + m}_{k_m}$$

which is the number of partitions of  $n$   $\{ \underbrace{m, \dots, m}_{k_m}, \underbrace{m-1, \dots, m-1}_{k_{m-1}}, \dots, \underbrace{2, \dots, 2}_{k_2}, \underbrace{1, \dots, 1}_{k_1} \}$

consider partition  $\{6, 6, 4, 3, 1\}$  of 20

$$m = 6 \text{ and } k_6 = 2, k_5 = 0, k_4 = 1, k_3 = 1, k_2 = 0, k_1 = 1.$$

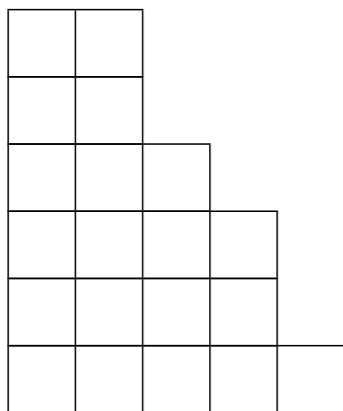

$$\mathbf{p}(z) = 1 + p(1)z + p(2)z^2 + p(3)z^3 + p(4)z^4 + \dots$$

$$\mathbf{p}(z) = 1 + z + 2z^2 + 3z^3 + 5z^4 + 7z^5 + 11z^6 + 15z^7 + 22z^8 + 30z^9 + 42z^{10} + 56z^{11} + 77z^{12} + 101z^{13} + \dots$$



# Recurrent Formula for $p(n)$

{1, 1, 2, 3, 5, 7, 11, 15, 22, 30, 42, 56, 77, 101, 135, 176, 231, 297, 385, 490, 627}

$$p(n) = p(n-1) + p(n-2) - p(n-5) - p(n-7) + p(n-12) + p(n-15) - p(n-22) - p(n-26) + \dots$$

$$5 = 3 + 2,$$

$$11 = 7 + 5 - 1,$$

$$15 = 11 + 7 - 2 - 1,$$

$$56 = 42 + 30 - 11 - 5,$$

$$77 = 56 + 42 - 15 - 7 + 1,$$

$$101 = 77 + 56 - 22 - 11 + 1.$$



# Plane Partitions

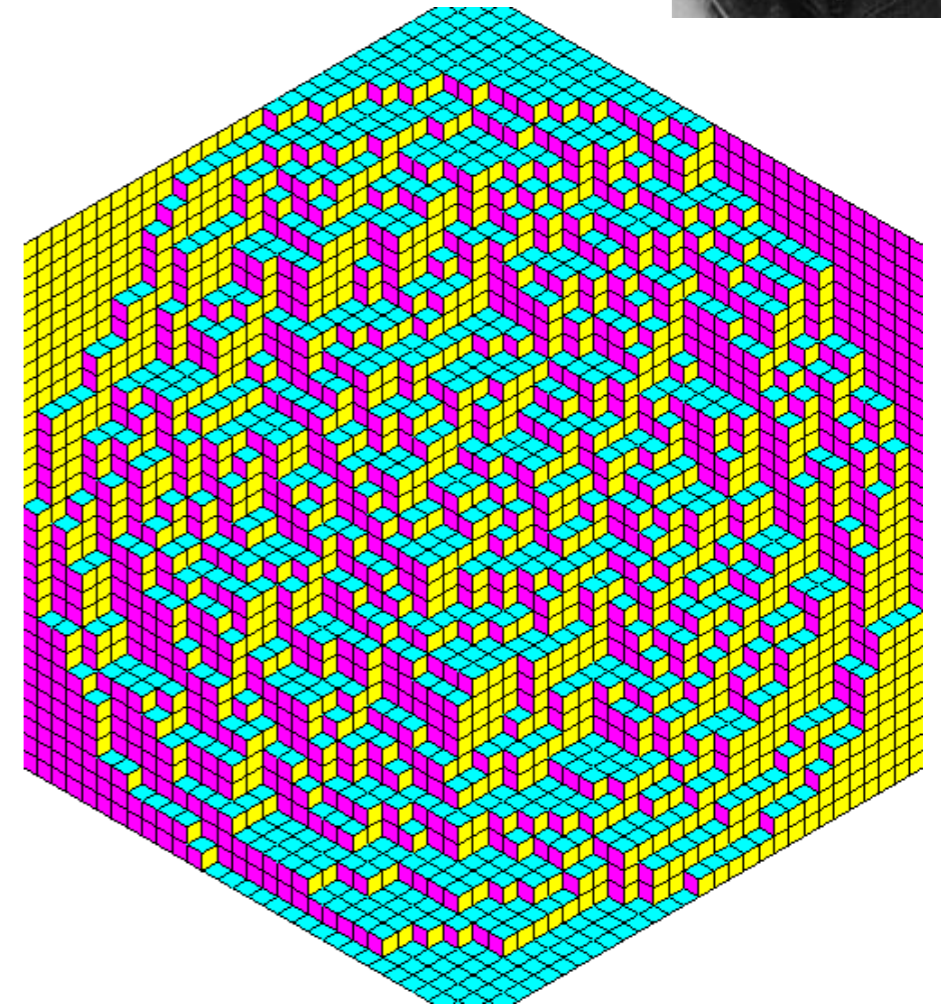
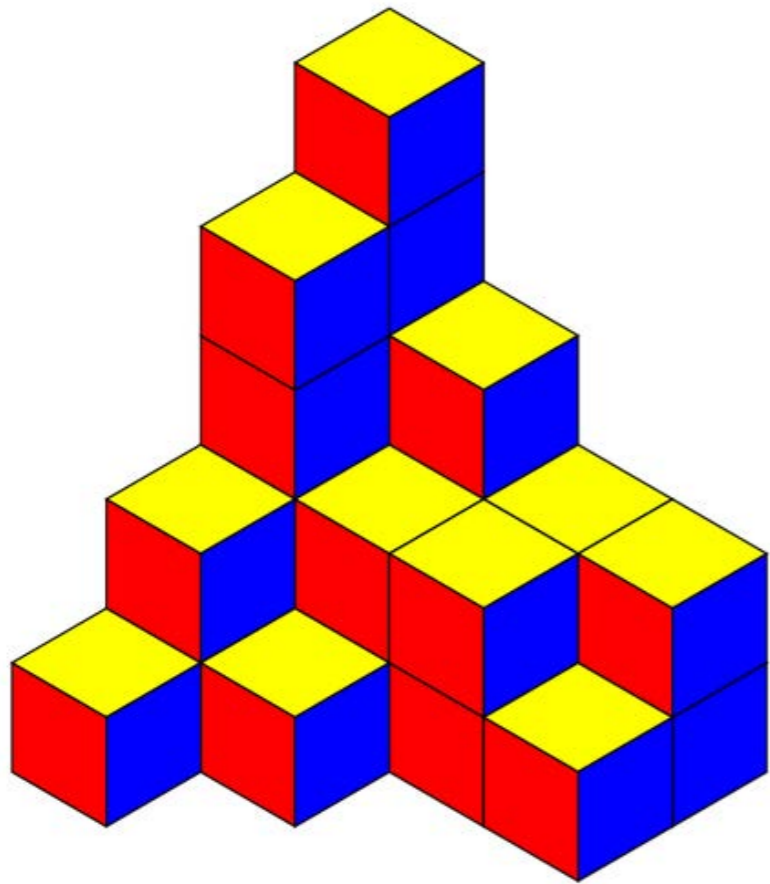

$$\sum_{n=0}^{\infty} \text{PL}(n)x^n = \prod_{k=1}^{\infty} \frac{1}{(1-x^k)^k} = 1 + x + 3x^2 + 6x^3 + 13x^4 + 24x^5 + \dots$$

# Appendix

# p(9)

{{**9**}, {8, 1}, {7, 2}, {7, 1, 1}, {6, 3}, {6, 2, 1}, {6, 1, 1, 1}, {5, 4}, {5, 3, 1}, {5, 2, 2},  
{5, 2, 1, 1}, {5, 1, 1, 1, 1}, {4, 4, 1}, {4, 3, 2}, {4, 3, 1, 1}, {4, 2, 2, 1}, {4, 2, 1, 1, 1},  
{4, 1, 1, 1, 1, 1}, {3, 3, 3}, {3, 3, 2, 1}, {3, 3, 1, 1, 1}, {3, 2, 2, 2}, {3, 2, 2, 1, 1},  
{3, 2, 1, 1, 1, 1}, {3, 1, 1, 1, 1, 1, 1}, {2, 2, 2, 2, 1}, {2, 2, 2, 1, 1, 1}, {2, 2, 1, 1, 1, 1, 1},  
{2, 1, 1, 1, 1, 1, 1, 1}, {1, 1, 1, 1, 1, 1, 1, 1, 1}}

# $p(10)$

$\{\{10\}, \{9, 1\}, \{8, 2\}, \{8, 1, 1\}, \{7, 3\}, \{7, 2, 1\}, \{7, 1, 1, 1\}, \{6, 4\}, \{6, 3, 1\}, \{6, 2, 2\}, \{6, 2, 1, 1\}, \{6, 1, 1, 1, 1\}, \{5, 5\}, \{5, 4, 1\}, \{5, 3, 2\}, \{5, 3, 1, 1\}, \{5, 2, 2, 1\}, \{5, 2, 1, 1, 1\}, \{5, 1, 1, 1, 1, 1\}, \{4, 4, 2\}, \{4, 4, 1, 1\}, \{4, 3, 3\}, \{4, 3, 2, 1\}, \{4, 3, 1, 1, 1\}, \{4, 2, 2, 2\}, \{4, 2, 2, 1, 1\}, \{4, 2, 1, 1, 1, 1\}, \{4, 1, 1, 1, 1, 1, 1\}, \{3, 3, 3, 1\}, \{3, 3, 2, 2\}, \{3, 3, 2, 1, 1\}, \{3, 3, 1, 1, 1, 1\}, \{3, 2, 2, 2, 1\}, \{3, 2, 2, 1, 1, 1\}, \{3, 2, 1, 1, 1, 1, 1\}, \{3, 1, 1, 1, 1, 1, 1, 1\}, \{2, 2, 2, 2, 2\}, \{2, 2, 2, 2, 1, 1\}, \{2, 2, 2, 1, 1, 1, 1\}, \{2, 2, 1, 1, 1, 1, 1, 1\}, \{2, 1, 1, 1, 1, 1, 1, 1, 1\}, \{1, 1, 1, 1, 1, 1, 1, 1, 1, 1\}\}$

# $p(11)$

$\{\{11\}, \{10, 1\}, \{9, 2\}, \{9, 1, 1\}, \{8, 3\}, \{8, 2, 1\}, \{8, 1, 1, 1\}, \{7, 4\}, \{7, 3, 1\}, \{7, 2, 2\}, \{7, 2, 1, 1\}, \{7, 1, 1, 1, 1\}, \{6, 5\}, \{6, 4, 1\}, \{6, 3, 2\}, \{6, 3, 1, 1\}, \{6, 2, 2, 1\}, \{6, 2, 1, 1, 1\}, \{6, 1, 1, 1, 1, 1\}, \{5, 5, 1\}, \{5, 4, 2\}, \{5, 4, 1, 1\}, \{5, 3, 3\}, \{5, 3, 2, 1\}, \{5, 3, 1, 1, 1\}, \{5, 2, 2, 2\}, \{5, 2, 2, 1, 1\}, \{5, 2, 1, 1, 1, 1\}, \{5, 1, 1, 1, 1, 1, 1\}, \{4, 4, 3\}, \{4, 4, 2, 1\}, \{4, 4, 1, 1, 1\}, \{4, 3, 3, 1\}, \{4, 3, 2, 2\}, \{4, 3, 2, 1, 1\}, \{4, 3, 1, 1, 1, 1\}, \{4, 2, 2, 2, 1\}, \{4, 2, 2, 1, 1, 1\}, \{4, 2, 1, 1, 1, 1, 1\}, \{4, 1, 1, 1, 1, 1, 1, 1\}, \{3, 3, 3, 2\}, \{3, 3, 3, 1, 1\}, \{3, 3, 2, 2, 1\}, \{3, 3, 2, 1, 1, 1\}, \{3, 3, 1, 1, 1, 1, 1\}, \{3, 2, 2, 2, 2\}, \{3, 2, 2, 2, 1, 1\}, \{3, 2, 2, 1, 1, 1, 1\}, \{3, 2, 1, 1, 1, 1, 1, 1\}, \{3, 1, 1, 1, 1, 1, 1, 1, 1\}, \{2, 2, 2, 2, 2, 1\}, \{2, 2, 2, 2, 1, 1, 1\}, \{2, 2, 2, 1, 1, 1, 1, 1\}, \{2, 2, 1, 1, 1, 1, 1, 1, 1\}, \{2, 1, 1, 1, 1, 1, 1, 1, 1, 1\}, \{1, 1, 1, 1, 1, 1, 1, 1, 1, 1, 1\}\}$